



JECR3006SL-S EPI HYPERFAST SOFT RECOVERY RECTIFIER

Rev.1.1

DESCRIPTION

- ✧ Plastic package has underwriters laboratory flammability classification 94V-0
- ✧ Lead free in comply with EU RoHS 2011/65/EU directives
- ✧ Low reverse leakage current
- ✧ 4th Generation hyperfast diode with softer recovery
- ✧ Low recovery loss
- ✧ Applications for continuous current mode (CCM) power factor correction (PFC), active PFC in air conditioner, half-bridge/full-bridge switched-mode power supplies

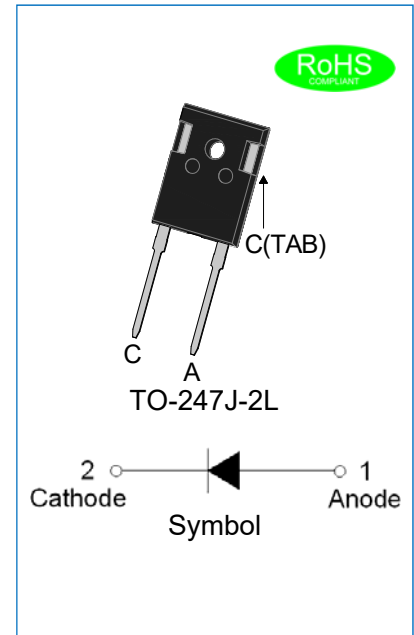

MECHANICAL DATA

- ✧ Case: TO-247J-2L molded plastic
- ✧ Terminals: Solder plated, solderable per J-STD-002
- ✧ Weight: 5.75gram

ABSOLUTE MAXIMUM RATING (Rating at 25°C ambient temperature unless otherwise specified.)

Parameter	Symbol	JECR3006SL-S	Unit
Maximum repetitive peak reverse voltage	V_{RRM}	600	V
Maximum RMS voltage	V_{RMS}	420	V
Maximum DC blocking voltage	V_{DC}	600	V
Average forward current $T_{mb}=115^{\circ}C$	$I_{F(AV)}$	30	A
Peak forward surge current: 10ms single half sine-wave superimposed on rated load	I_{FSM}	270	A
Peak forward surge current: 8.3ms single half sine-wave superimposed on rated load		300	
Junction temperature and storage temperature range	T_j, T_{stg}	-55 to +150	°C

ELECTRICAL CHARACTERISTICS(Rating at 25°C ambient temperature unless otherwise specified.)

Parameter		Symbol	Min.	Typ.	Max.	Unit
Forward voltage	$I_F=30A, T_J=25^\circ C$	V_F	-	2.1	2.75	V
	$I_F=30A, T_J=150^\circ C$		-	1.5	2.0	
Reverse current	$V_R=600V, T_J=25^\circ C$	I_R	-	-	5	μA
	$V_R=600V, T_J=150^\circ C$		-	-	400	
Reverse recovery time	$I_F=1A, V_R=30V,$ $di/dt=50A/\mu s, T_J=25^\circ C$	t_{rr}	-	-	45	ns
	$I_F=30A, V_R=200V,$ $di/dt=200A/\mu s, T_J=25^\circ C$		-	60	-	
	$I_F=30A, V_R=200V,$ $di/dt=200A/\mu s, T_J=125^\circ C$		-	105	-	
Peak reverse recovery current	$I_F=30A, V_R=200V,$ $di/dt=200A/\mu s, T_J=25^\circ C$	I_{RM}	-	4	-	A
	$I_F=30A, V_R=200V,$ $di/dt=200A/\mu s, T_J=125^\circ C$		-	10	-	
Recovered charge	$I_F=30A, V_R=200V,$ $di/dt=200A/\mu s, T_J=25^\circ C$	Q_r	-	135	-	nC
	$I_F=30A, V_R=200V,$ $di/dt=200A/\mu s, T_J=125^\circ C$		-	600	-	
Softness factor	$I_F=30A, V_R=200V,$ $di/dt=200A/\mu s, T_J=125^\circ C$	S_{factor}	-	0.55	-	-

THERMAL RESISTANCES

Symbol	Parameter	Min.	Typ.	Max.	Unit
$R_{th(j-mb)}$	Thermal resistance from junction to mounting base	-	-	1	$^\circ C/W$
$R_{th(j-a)}$	Thermal resistance from junction to ambient free air	-	44	-	$^\circ C/W$

MARKING

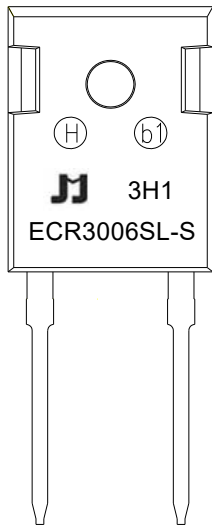

ECR	EPI Hyperfast Recovery Rectifier
30	$I_{F(AV)}=30A$
06	$V_{RRM}:600V$
SL	Package:TO-247J-2L
S	Softer Recovery

$\underline{x}H1$: Month, 1/2/3~9/A/B/C

$3\underline{x}1$:

2018	2019	2020	2021	2022	2023	2024
H	I	J	K	L	M	N
2025	2026	2027	2028	2029	2030	...
O	P	Q	R	S	T	...

$3H\underline{x}$: Batch number

ORDERING INFORMATION

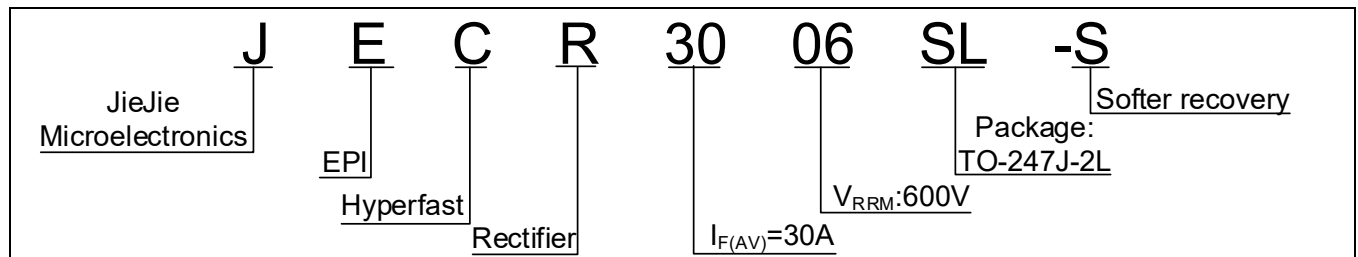

PACKAGE MECHANICAL DATA

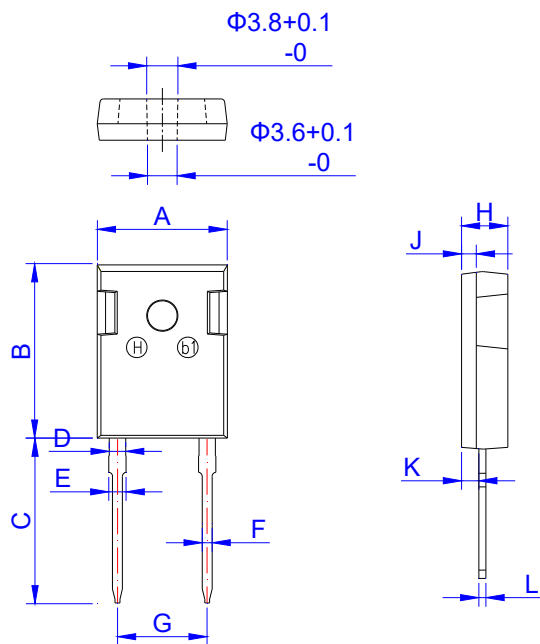

TO-247J-2L

Ref.	Dimensions					
	Millimeters			Inches		
	Min.	Typ.	Max.	Min.	Typ.	Max.
A	15.50	15.80	16.10	0.610	0.622	0.634
B	20.80	21.00	21.20	0.819	0.827	0.835
C	19.70	20.00	20.30	0.776	0.787	0.799
D	1.80	2.00	2.20	0.071	0.079	0.087
E	1.90	2.10	2.30	0.075	0.083	0.091
F	1.00	1.20	1.40	0.039	0.047	0.055
G	10.50		11.30	0.413		0.445
H	4.80	5.00	5.20	0.189	0.197	0.205
J	1.90	2.00	2.10	0.075	0.079	0.083
K	2.20	2.35	2.50	0.087	0.093	0.098
L	0.41	0.60	0.79	0.016	0.024	0.031

PACKAGE INFORMATION-TO-247J-2L

OUTLINE	UNIT WEIGHT (g/PCS) TYP	TUBE (PCS)	PER CARTON (PCS)
TUBE	5.75	30	2,250

CHARACTERISTICS CURVE

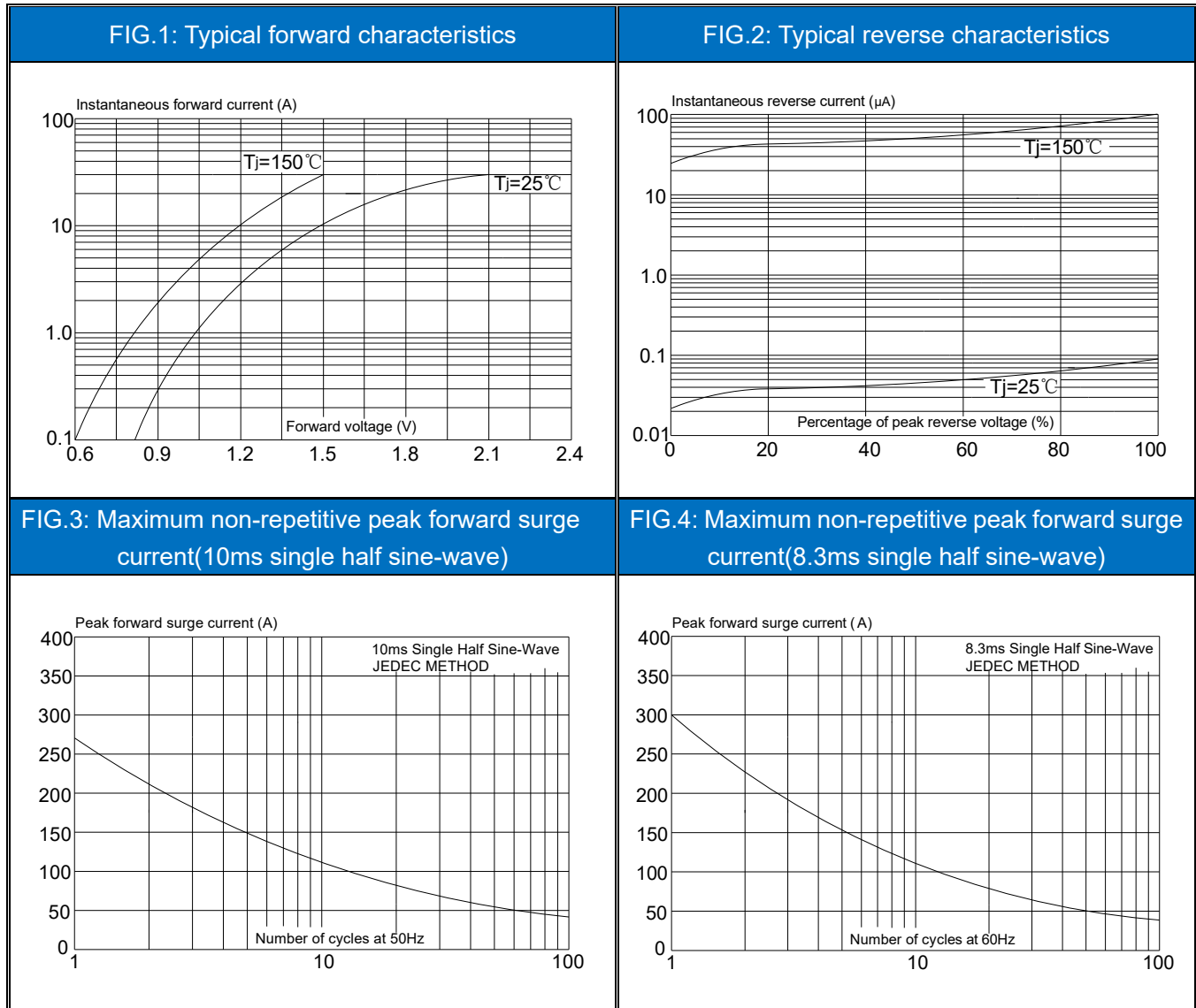

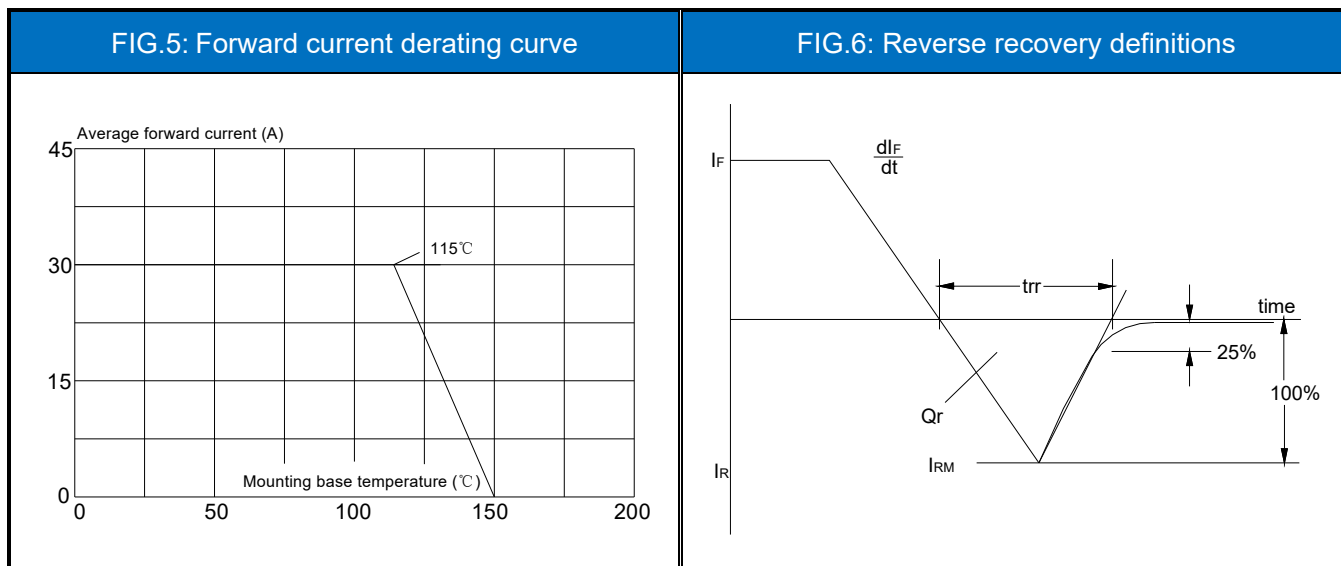

JieJie products are not designed for, and shall not be used for, any purpose (including, without limitation, automotive, military, aerospace, medical, life-saving, life-sustaining or nuclear facility applications, devices intended for surgical implant into the body, or any other application in which the failure or lack of desired operation of the product may result in personal injury, death, or property damage) other than those expressly set forth in applicable JieJie product documentation. Warranties granted by JieJie shall be deemed void for products used for any purpose not expressly set forth in applicable JieJie documentation. JieJie shall not be liable for any claims or damages arising out of products used in applications not expressly intended by JieJie as set forth in applicable JieJie documentation. The sale and use of JieJie products is subject to JieJie terms and conditions of sale, unless otherwise agreed by JieJie.

Information furnished in this document is believed to be accurate and reliable. However, Jiangsu JieJie Microelectronics Co., Ltd. assumes no responsibility for the consequences of use without consideration for such information nor use beyond it.

Information mentioned in this document is subject to change without notice, apart from that when an agreement is signed, Jiangsu JieJie complies with the agreement.

Products and information provided in this document have no infringement of patents. Jiangsu JieJie assumes no responsibility for any infringement of other rights of third parties which may result from the use of such products and information.

This document is the 1.1st version which is made in 16-Dec.-2023. This document supersedes and replaces all information previously supplied.

 is a registered trademark of Jiangsu JieJie Microelectronics Co., Ltd.

Copyright ©2023 Jiangsu JieJie Microelectronics Co., Ltd. Printed All rights reserved.