



## PxxxxLB Series TSS

Rev.1.1

### DESCRIPTION:

PxxxxLB series are a type of semiconductor component. They are designed to protect baseband equipment from damaging overvoltage transients.

### FEATURES:

- ✧ Low profile package.
- ✧ Low on-state voltage.
- ✧ Excellent capability of absorbing transient surge.
- ✧ Quick response to surge voltage (ns Level).
- ✧ Eliminates overvoltage caused by fast rising transients.
- ✧ Moisture sensitivity level: Level 1.
- ✧ UL 497B item recognized. (File No.: E480698).
- ✧ IEC61000-4-2 (ESD)  $\pm 30\text{kV}$  (air),  $\pm 30\text{kV}$  (contact).
- ✧ Non degenerative.

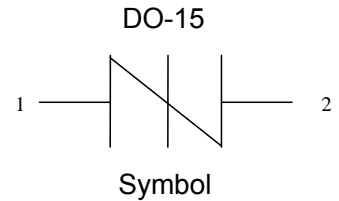
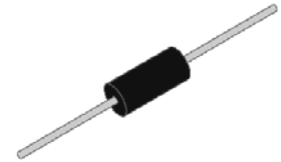

### ABSOLUTE MAXIMUM RATINGS( $T_A=25^\circ\text{C}$ , RH=45%-75%, unless otherwise noted)

Parameter	Symbol	Value	Unit
Storage temperature range	$T_{STG}$	-60 to +150	$^\circ\text{C}$
Operating junction temperature range	$T_J$	-40 to +125	$^\circ\text{C}$
Repetitive peak pulse current@10/1000 $\mu\text{s}$	$I_{PP}$	80	A

### ELECTRICAL CHARACTERISTICS( $T_A=25^\circ\text{C}$ )

Symbol	Parameter
$V_{DRM}$	Peak off-state voltage
$I_{DRM}$	Off-state current
$V_S$	Switching voltage
$I_S$	Switching current
$V_T$	On-state voltage
$I_T$	On-state current
$I_H$	Holding current
$C_O$	Off-state capacitance

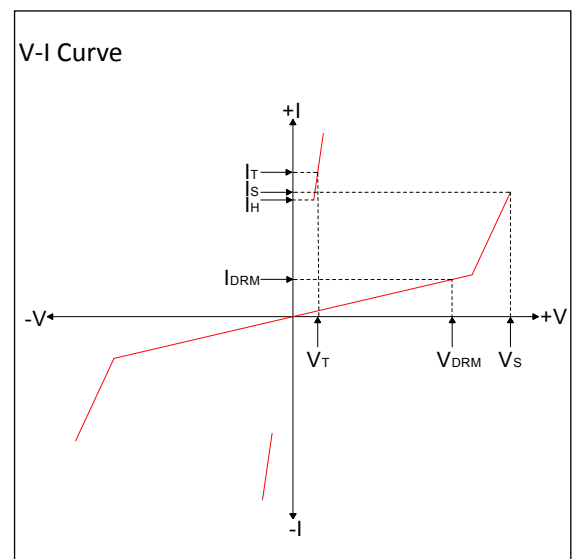

**ELECTRICAL CHARACTERISTICS**( $T_A=25^{\circ}\text{C}$ , continued)

Part Number	$I_{\text{DRM}}@V_{\text{DRM}}$		$V_{\text{S}}^{\text{①}}@I_{\text{S}}$		$V_{\text{T}}@I_{\text{T}}$		$I_{\text{H}}$	$C_{\text{O}}^{\text{②}}$
	$\mu\text{A}$	V	V	mA	V	A	mA	pF
	max		max	max	max	max	min	max
P0080LB	1	6	15	800	4	2.2	50	130
P0220LB	1	15	30	800	4	2.2	50	120
P0300LB	1	25	40	800	4	2.2	50	120
P0640LB	1	58	77	800	4	2.2	120	80
P0720LB	1	66	87	800	4	2.2	120	75
P0900LB	1	75	98	800	4	2.2	120	70
P1100LB	1	90	130	800	4	2.2	120	70
P1300LB	1	120	160	800	4	2.2	120	60
P1500LB	1	140	180	800	4	2.2	120	55
P1800LB	1	170	220	800	4	2.2	120	50
P2300LB	1	190	260	800	4	2.2	120	50
P2600LB	1	220	300	800	4	2.2	120	45
P3100LB	1	275	350	800	4	2.2	120	45
P3500LB	1	320	400	800	4	2.2	150	40

①  $V_{\text{S}}$  is measured at 100kV/s

② Off-state capacitance is measured in  $V_{\text{DC}}=2\text{V}$ ,  $V_{\text{RMS}}=1\text{V}$ ,  $f=1\text{MHz}$

**SURGE RATINGS**

Series	$I_{\text{PP}}(\text{A})$ min			
	2/10 $\mu\text{s}$	8/20 $\mu\text{s}$	10/360 $\mu\text{s}$	10/1000 $\mu\text{s}$
B	250	250	125	80

**ORDERING INFORMATION**

<b>P</b>	<b>008</b>	<b>0</b>	<b>L</b>	<b>B</b>
Series code P: SIDACTor	Median voltage	0: Bi-direction	Package type: DO-15	Surge ratings:4kV(10/700 $\mu\text{s}$ )

**SOLDERING PARAMETERS**

Reflow Condition		Pb-Free assembly (see figure at right)
Pre Heat	-Temperature Min ( $T_{s(min)}$ )	+150°C
	-Temperature Max( $T_{s(max)}$ )	+200°C
	-Time (Min to Max) ( $t_s$ )	60-180 secs.
Average ramp up rate (Liquidus Temp ( $T_L$ ) to peak)		3°C/sec. Max
$T_{s(max)}$ to $T_L$ - Ramp-up Rate		3°C/sec. Max
Reflow	-Temperature( $T_L$ )(Liquidus)	+217°C
	-Temperature( $t_L$ )	60-150 secs.
Peak Temp ( $T_p$ )		+260(+0/-5)°C
Time within 5°C of actual Peak Temp ( $t_p$ )		30secs.Max
Ramp-down Rate		6°C/sec. Max
Time 25°C to Peak Temp ( $T_p$ )		8 min. Max
Do not exceed		+260°C

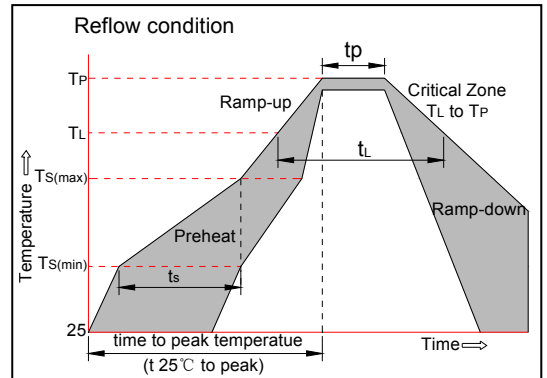

Flow/Wave Soldering(Solder Dipping)	
Peak Temperature	260°C
Dipping Time	5 seconds
Soldering	1 time

**FIG.1:** Normalized Vs change vs. junction temperature

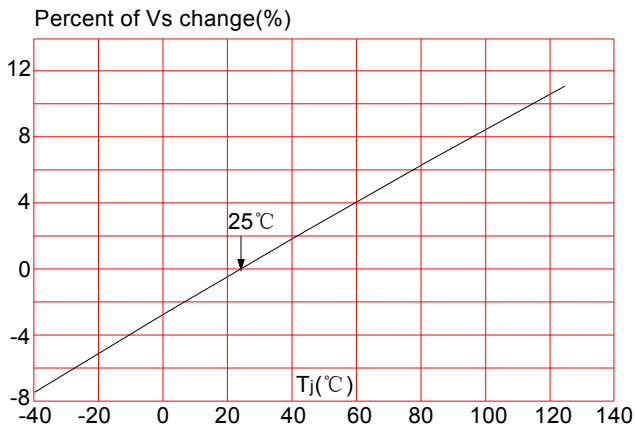

**FIG.2:** Normalized DC holding current vs. case temperature

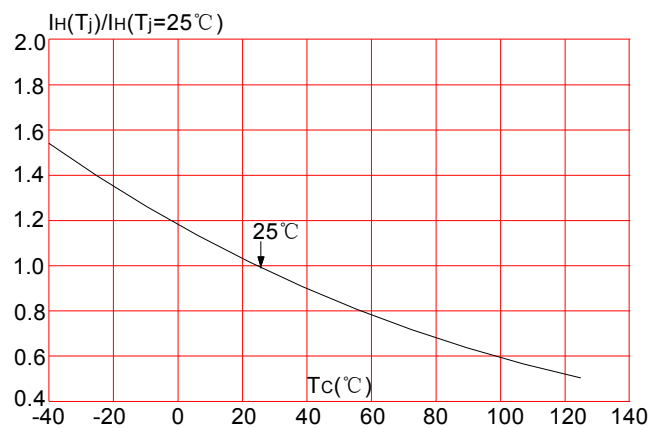
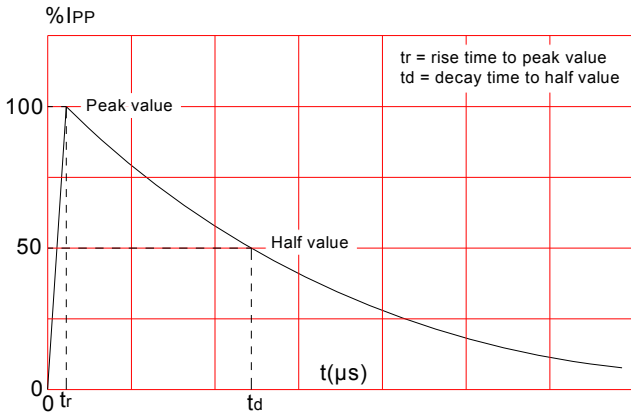

FIG.3: tr × td pulse waveform



MARKING & ORDERING INFORMATION



Product Type

- |     |     |     |     |     |
|-----|-----|-----|-----|-----|
| P   | xxx | x   | L   | B   |
| (1) | (2) | (3) | (4) | (5) |
- (1)Thyristor surge suppressors
  - (2) $V_s$  voltage code
  - (3)Bi-directional
  - (4)Package:DO-15
  - (5)Surge ratings:4kV(10/700μs)

PACKAGE MECHANICAL DATA

<p style="text-align: center;">DO-15</p>	Ref.	Dimensions			
		Millimeters		Inches	
		Min.	Max.	Min.	Max.
	A	25.40	-	1.000	-
B	5.80	7.62	0.228	0.300	
C	0.71	0.86	0.028	0.034	
D	2.60	3.60	0.102	0.142	

TAPE AND BOX SPECIFICATION-DO-15

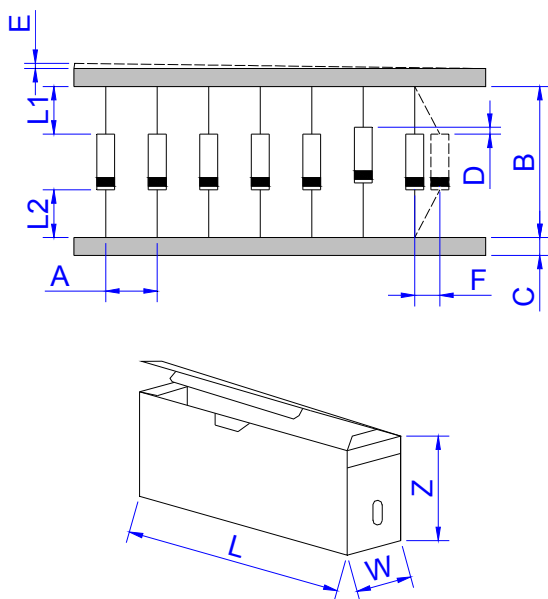

Ref.	Dimensions	
	Millimeters	Inches
A	5.0±0.5	0.197±0.020
B	53.0±1.5	2.087±0.059
C	6.0±0.5	0.236±0.020
D	1.2(MAX)	0.047(MAX)
E	0.8(MAX)	0.031(MAX)
F	1.5(MAX)	0.059(MAX)
L1-L2	1.0(MAX)	0.039(MAX)
W	80±5.0	3.150±0.197
L	250±5.0	9.843±0.197
Z	115±5.0	4.528±0.197

PART No.	UNIT WEIGHT (g/PCS) typ.	PER BOX (PCS)	PER CARTON (PCS)	DESCRIPTION
PxxxxLB	0.42	2,000	20,000	Box

Information furnished in this document is believed to be accurate and reliable. However, Jiangsu JieJie Microelectronics Co.,Ltd assumes no responsibility for the consequences of use without consideration for such information nor use beyond it.

Information mentioned in this document is subject to change without notice, apart from that when an agreement is signed, Jiangsu JieJie complies with the agreement.

Products and information provided in this document have no infringement of patents. Jiangsu JieJie assumes no responsibility for any infringement of other rights of third parties which may result from the use of such products and information.

This document is the 1.1st version which is made in 11-Aug.-2021. This document supersedes and replaces all information previously supplied.

 is a registered trademark of Jiangsu JieJie Microelectronics Co.,Ltd.

Copyright©2021 Jiangsu JieJie Microelectronics Co.,Ltd. Printed All rights reserved.