



FEATURES

- ◇ 60 watts peak pulse power per line ($t_P=8/20\mu s$)
- ◇ Protects two I/O lines with uni-directional
- ◇ Low clamping voltage
- ◇ Ultra-low capacitance: $C_J=0.4pF$ typ.
- ◇ Working voltage:5V
- ◇ Low leakage current
- ◇ RoHS compliant

MAIN APPLICATIONS

- ◇ USB 2.0 and USB 3.0
- ◇ HDMI 1.3 and HDMI 1.4
- ◇ SATA and eSATA
- ◇ DVI
- ◇ PCI Express
- ◇ Portable Electronics
- ◇ IEEE 1394

PROTECTION SOLUTION TO MEET

- ◇ IEC61000-4-2 (ESD) $\pm 20kV$ (air), $\pm 20kV$ (contact)
- ◇ IEC61000-4-4 (EFT) 40A (5/50ns)
- ◇ IEC61000-4-5 (lightning) 4A (8/20 μs)

MECHANICAL CHARACTERISTICS

- ◇ SOT-23 package
- ◇ Molding compound flammability rating: UL 94V-0
- ◇ Weight 8 milligrams (approximate)
- ◇ Quantity per reel: 3,000pcs
- ◇ Reel size: 7 inch
- ◇ Lead finish: lead free
- ◇ Marking code: W02*

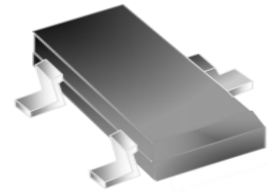

SOT-23

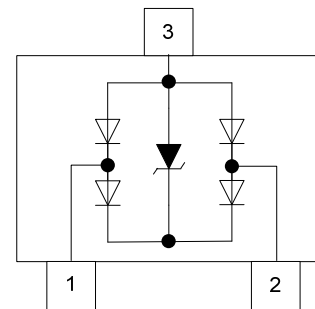

Pin Configuration

ABSOLUTE MAXIMUM RATINGS ($T_A=25^{\circ}\text{C}$, RH=45%-75%, unless otherwise noted)

Parameter	Symbol	Value	Unit
Peak pulse power dissipation on 8/20 μs waveform	P_{PP}	60	W
ESD per IEC 61000-4-2 (Air)	V_{ESD}	+/- 20	kV
ESD per IEC 61000-4-2 (Contact)		+/- 20	
Lead soldering temperature	T_L	260 (10 sec.)	$^{\circ}\text{C}$
Operating junction temperature range	T_J	-55 to +125	$^{\circ}\text{C}$
Storage temperature range	T_{STG}	-55 to +150	$^{\circ}\text{C}$

ELECTRICAL CHARACTERISTICS ($T_A=25^{\circ}\text{C}$)

Parameter	Symbol	Conditions	Min	Typ	Max	Unit
Reverse working voltage	V_{RWM}				5.0	V
Reverse breakdown voltage	V_{BR}	$I_T=1\text{mA}$ Any I/O pin to GND	6.0	7.7	9.0	V
Reverse leakage current	I_R	$V_{RWM}=5\text{V}$ Any I/O pin to GND			100	nA
Clamping voltage	V_C	$I_{PP}=1\text{A}$, $t_p=8/20\mu\text{s}$ Any I/O pin to GND		8.2	11	V
		$I_{PP}=4\text{A}$, $t_p=8/20\mu\text{s}$ Any I/O pin to GND		10.6	15	V
Junction capacitance	C_J	$V_R=0\text{V}$, $f=1\text{MHz}$ Any I/O pin to GND		0.4	0.65	pF
		$V_R=0\text{V}$, $f=1\text{MHz}$ Between any I/O pin		0.25	0.40	

RATINGS AND V-I CHARACTERISTICS CURVES ($T_A=25^{\circ}\text{C}$, unless otherwise noted)

FIG.1: V- I curve characteristics (Uni-directional)

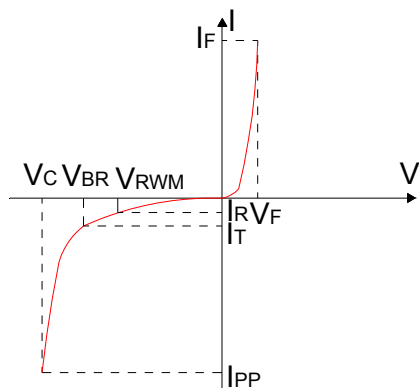

FIG.2: Pulse waveform (8/20 μs)

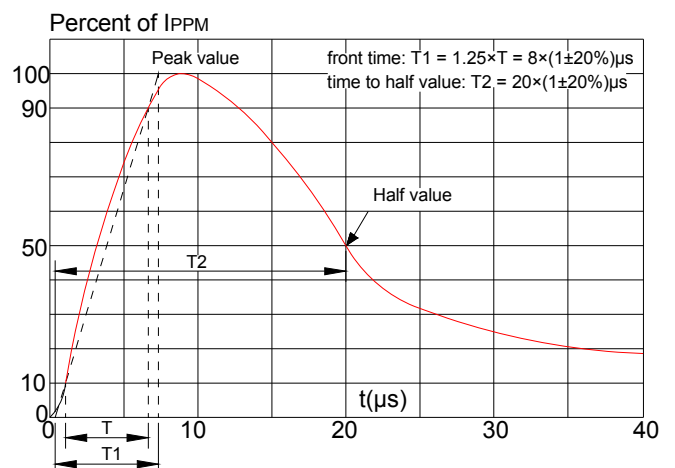

FIG.3: Pulse derating curve

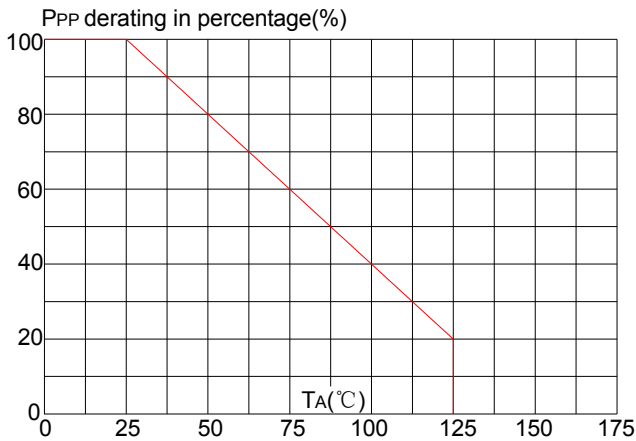
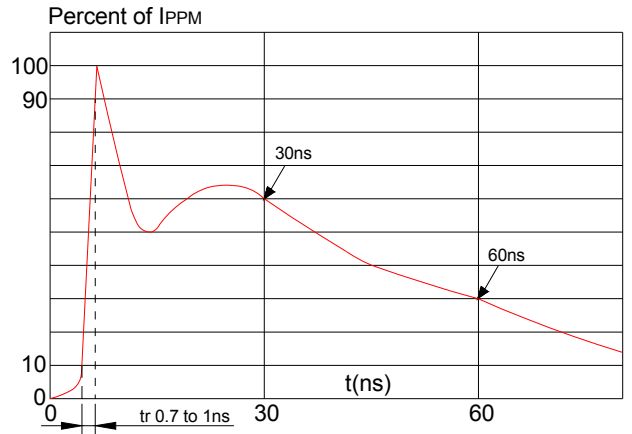
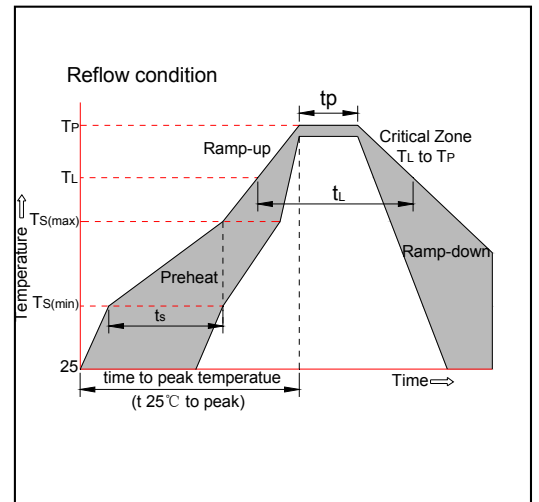

FIG.4: ESD clamping (20kV contact)



SOLDERING PARAMETERS

Reflow Condition		Pb-Free assembly (see figure at right)
Pre Heat	-Temperature Min (Ts(min))	+150°C
	-Temperature Max(Ts(max))	+200°C
	-Time (Min to Max) (ts)	60-180 secs.
Average ramp up rate (Liquidus Temp (TL)to peak)		3°C/sec. Max
Ts(max) to TL - Ramp-up Rate		3°C/sec. Max
Reflow	-Temperature(TL)(Liquidus)	+217°C
	-Temperature(tL)	60-150 secs.
Peak Temp (Tp)		+260(+0/-5)°C
Time within 5°C of actual Peak Temp (tp)		20-40secs.
Ramp-down Rate		6°C/sec. Max
Time 25°C to Peak Temp (Tp)		8 min. Max
Do not exceed		+260°C



PACKAGE MECHANICAL DATA

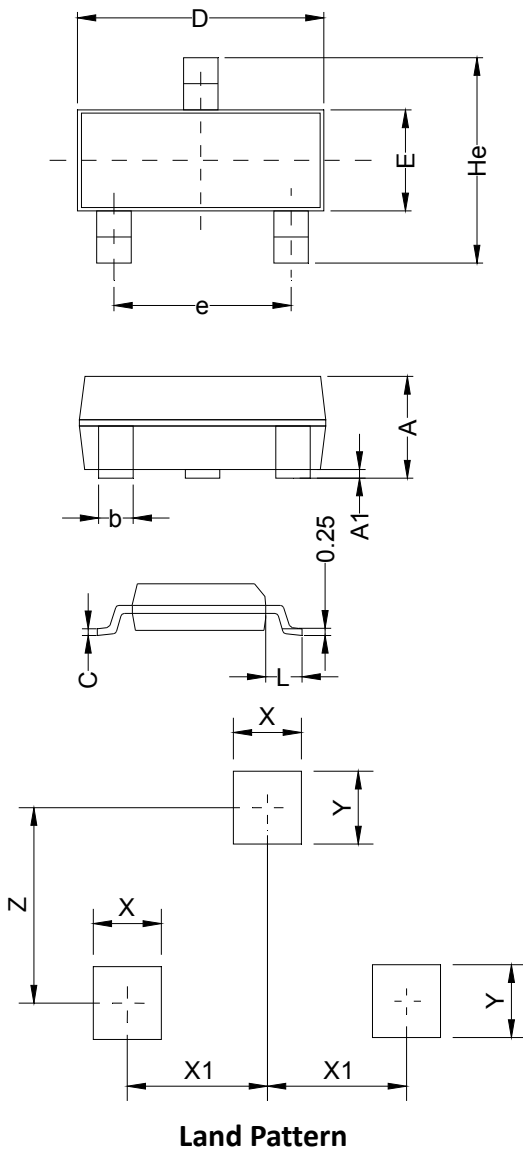

Symbol	Millimeters			Inches		
	Min.	Typ.	Max.	Min.	Typ.	Max.
A	0.90	1.063	1.15	0.035	0.042	0.045
A1	0.00	0.075	0.14	0.000	0.003	0.006
b	0.30	0.40	0.50	0.012	0.016	0.020
C	0.07	0.10	0.15	0.003	0.004	0.006
D	2.80	2.90	3.00	0.110	0.114	0.118
e	1.80	1.90	2.00	0.071	0.075	0.079
E	1.20	1.30	1.40	0.047	0.051	0.055
L	0.55REF			0.022REF		
He	2.25	2.40	2.55	0.089	0.094	0.100
X	0.80			0.031		
X1	0.95			0.037		
Y	0.80			0.031		
Z	2.02			0.080		

TAPE AND REEL SPECIFICATION-SOT-23

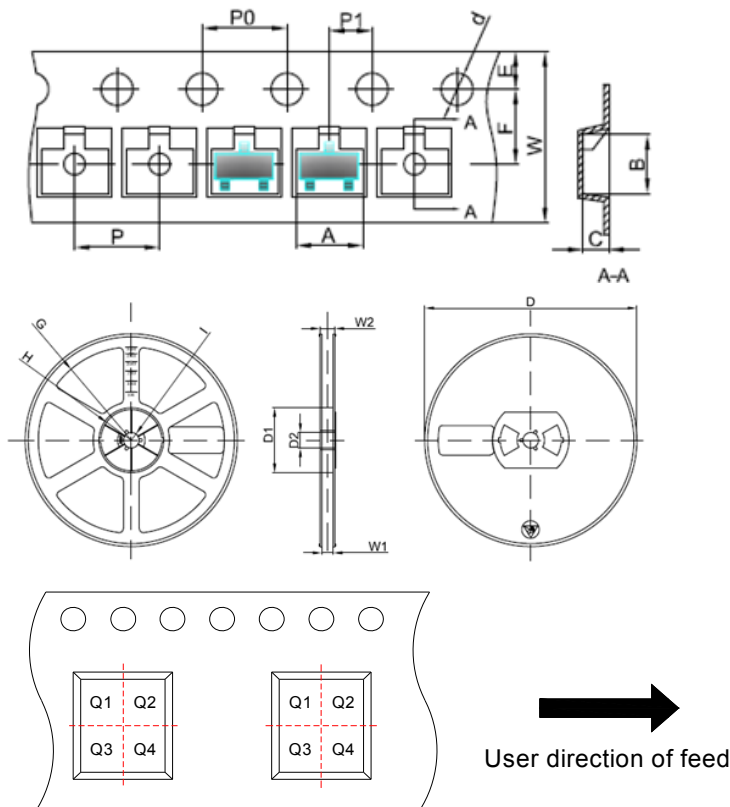

Pin 1 quadrant: Q3

Packaging Description:

SOT-23 parts are shipped in tape. The carrier tape is made from a dissipative(carbon filled) polycarbonate resin. The cover tape is a multilayer film(heat activated adhesive in nature)primarily composed of polyester film, adhesive layer, sealant, and anti-static sprayed agent. These reeled parts in standard option are shipped with 3,000units per 7" or 17.8cm diameter reel. The reels are clear in color and made of polystyrene plastic(anti-static coated).

Symbol	Millimeters	Inches
	Typ.	Typ.
A	3.15	0.124
B	2.77	0.109
C	1.22	0.048
d	Φ1.50	Φ0.059
E	1.75	0.069
F	3.50	0.138
P0	4.00	0.157
P	4.00	0.157
P1	2.00	0.079
W	8.00	0.315
D	Φ178	Φ7.008
D1	54.40	2.142
D2	13.00	0.512
G	R78.00	R3.071
H	R25.60	R1.008
I	R6.50	R0.256
W1	9.50	0.374
W2	12.30	0.484

ORDERING INFORMATION

PART No.	PACKAGE TYPE	QUANTITY(PCS) REEL	DESCRIPTION
JEU05UCT2B	SOT-23	3,000	7 inch reel pack

MARKING CODE

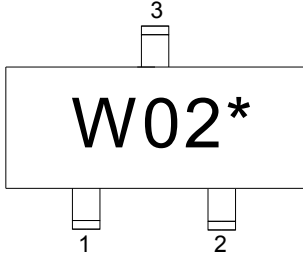
Part Number	Marking Code
JEU05UCT2B	 <p data-bbox="842 613 1090 687">W02=Device code *=Month code(A~Z)</p>

Information furnished in this document is believed to be accurate and reliable. However, Jiangsu JieJie Microelectronics Co.,Ltd assumes no responsibility for the consequences of use without consideration for such information nor use beyond it.

Information mentioned in this document is subject to change without notice, apart from that when an agreement is signed, Jiangsu JieJie complies with the agreement.

Products and information provided in this document have no infringement of patents. Jiangsu JieJie assumes no responsibility for any infringement of other rights of third parties which may result from the use of such products and information.

This document is the 1.4th version which is made in 1-July-2020. This document supersedes and replaces all information previously supplied.

 is a registered trademark of Jiangsu JieJie Microelectronics Co.,Ltd.

Copyright ©2020 Jiangsu JieJie Microelectronics Co.,Ltd. Printed All rights reserved.