



100V 2.1mΩ N-Ch Power MOSFET

Features

- Ultra-low $R_{DS(ON)}$
- Low Gate Charge
- 100% UIS Tested, 100% R_g Tested
- Pb-free Lead Plating
- Halogen-free and RoHS-compliant

Product Summary

Parameter	Value	Unit
V_{DS}	100	V
$V_{GS(th)}$	3.0	V
I_D (@ $V_{GS} = 10V$) ⁽¹⁾	246	A
$R_{DS(ON)}$ (@ $V_{GS} = 10V$)	2.1	mΩ

Applications

- Motor Driving in Power Tool, E-vehicle, Robotics
- Current Switching in DC/DC & AC/DC (SR) Sub-systems
- Power Management in Telecom., Industrial Automation, CE

PowerJE®10x12 Top View

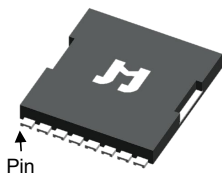

PowerJE®10x12 Bottom View

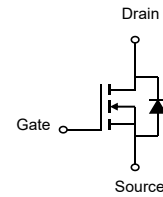
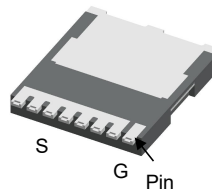

Ordering Information

Device	Package	# of Pins	Marking	MSL	T_J (°C)	Media	Quantity (pcs)
JVL102E	PowerJE®10x12	8	VL102E	1	-55 to 150	13-inch Reel	2000

Absolute Maximum Ratings (@ $T_A = 25^\circ\text{C}$ unless otherwise specified)

Parameter	Symbol	Value	Unit
Drain-to-Source Voltage	V_{DS}	100	V
Gate-to-Source Voltage	V_{GS}	±20	V
Continuous Drain Current ⁽¹⁾	I_D	$T_C = 25^\circ\text{C}$	246
		$T_C = 100^\circ\text{C}$	156
Pulsed Drain Current ⁽²⁾	I_{DM}	984	A
Avalanche Energy ⁽³⁾	E_{AS}	1350	mJ
Power Dissipation ⁽⁴⁾	P_D	$T_C = 25^\circ\text{C}$	290
		$T_C = 100^\circ\text{C}$	116
Junction & Storage Temperature Range	T_J, T_{STG}	-55 to 150	°C

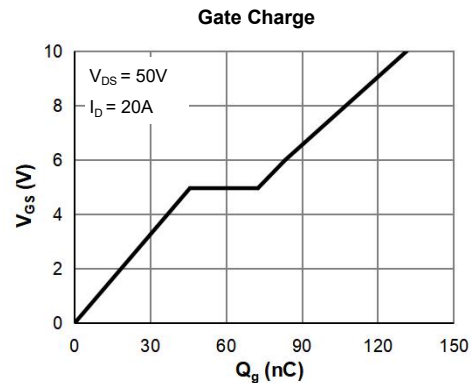
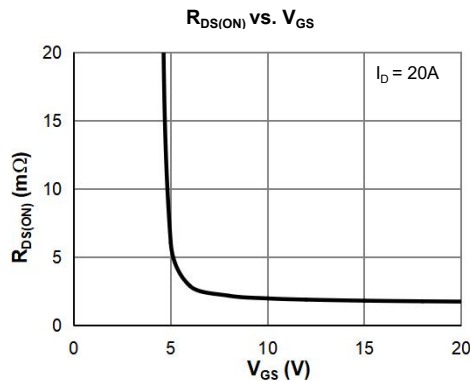



Electrical Characteristics (@ $T_J = 25^\circ\text{C}$ unless otherwise specified)

Parameter	Symbol	Conditions	Min.	Typ.	Max.	Unit
STATIC PARAMETERS						
Drain-Source Breakdown Voltage	$V_{(BR)DSS}$	$I_D = 250\mu\text{A}, V_{GS} = 0\text{V}$	100	106		V
Zero Gate Voltage Drain Current	I_{DSS}	$V_{DS} = 80\text{V}, V_{GS} = 0\text{V}$ $T_J = 55^\circ\text{C}$			1.0 5.0	μA
Gate-Body Leakage Current	I_{GSS}	$V_{DS} = 0\text{V}, V_{GS} = \pm 20\text{V}$			± 100	nA
Gate Threshold Voltage	$V_{GS(th)}$	$V_{DS} = V_{GS}, I_D = 250\mu\text{A}$	2.0	3.0	4.0	V
Static Drain-Source ON-Resistance	$R_{DS(ON)}$	$V_{GS} = 10\text{V}, I_D = 20\text{A}$		2.1	2.6	$\text{m}\Omega$
Forward Transconductance	g_{FS}	$V_{DS} = 5\text{V}, I_D = 20\text{A}$		67		S
Diode Forward Voltage	V_{SD}	$I_S = 1\text{A}, V_{GS} = 0\text{V}$		0.66	1.0	V
Diode Continuous Current	I_S	$T_C = 25^\circ\text{C}$			246	A
DYNAMIC PARAMETERS ⁽⁵⁾						
Input Capacitance	C_{iss}	$V_{GS} = 0\text{V}, V_{DS} = 50\text{V}, f = 1\text{MHz}$		9256		pF
Output Capacitance	C_{oss}			1318		pF
Reverse Transfer Capacitance	C_{rss}			30		pF
Gate Resistance	R_g	$V_{GS} = 0\text{V}, V_{DS} = 0\text{V}, f = 1\text{MHz}$		1.0		Ω
SWITCHING PARAMETERS ⁽⁵⁾						
Total Gate Charge (@ $V_{GS} = 10\text{V}$)	Q_g	$V_{GS} = 0 \text{ to } 10\text{V}$ $V_{DS} = 50\text{V}, I_D = 20\text{A}$		131		nC
Total Gate Charge (@ $V_{GS} = 6.0\text{V}$)	Q_g			83		nC
Gate Source Charge	Q_{gs}			46		nC
Gate Drain Charge	Q_{gd}			27		nC
Turn-On DelayTime	$t_{D(on)}$	$V_{GS} = 10\text{V}, V_{DS} = 50\text{V}$ $R_L = 2.5\Omega, R_{GEN} = 3\Omega$		33		ns
Turn-On Rise Time	t_r			33		ns
Turn-Off DelayTime	$t_{D(off)}$			63		ns
Turn-Off Fall Time	t_f			23		ns
Body Diode Reverse Recovery Time	t_{rr}	$I_F = 20\text{A}, dI_F/dt = 100\text{A}/\mu\text{S}$		91		ns
Body Diode Reverse Recovery Charge	Q_{rr}	$I_F = 20\text{A}, dI_F/dt = 100\text{A}/\mu\text{S}$		250		nC

Thermal Performance

Parameter	Symbol	Typ.	Max.	Unit
Thermal Resistance, Junction-to-Ambient	$R_{\theta JA}$	45	55	$^\circ\text{C}/\text{W}$
Thermal Resistance, Junction-to-Case	$R_{\theta JC}$	0.33	0.43	$^\circ\text{C}/\text{W}$

Notes:

1. Computed continuous current assumes the condition of T_{J_Max} while the actual continuous current depends on the thermal & electro-mechanical application board design.
2. This single-pulse measurement was taken under $T_{J_Max} = 150^\circ\text{C}$.
3. E_{AS} of 1350 mJ is based on starting $T_J = 25^\circ\text{C}$, $L = 3.0\text{mH}$, $I_{AS} = 30\text{A}$, $V_{GS} = 10\text{V}$, $V_{DD} = 50\text{V}$; 100% test at $L = 0.3\text{mH}$, $I_{AS} = 62\text{A}$.
 $T_{J_Max} = 150^\circ\text{C}$.
4. The power dissipation P_D is based on $T_{J_Max} = 150^\circ\text{C}$.
5. This value is guaranteed by design hence it is not included in the production test.

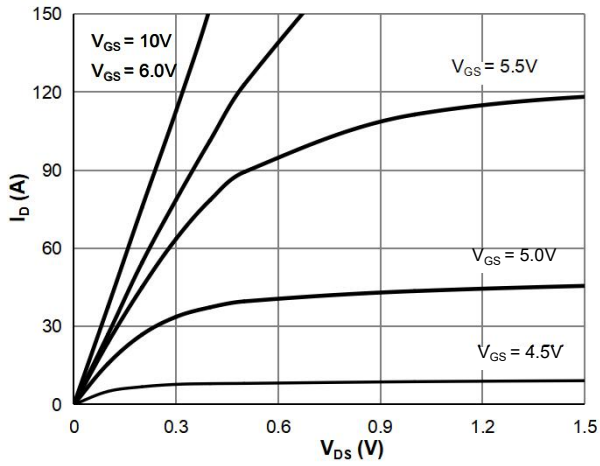
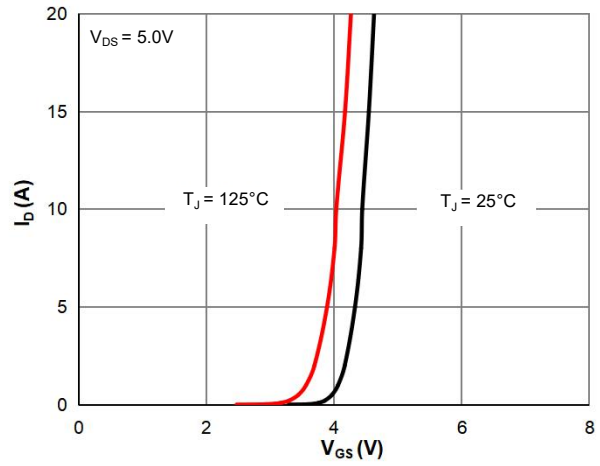
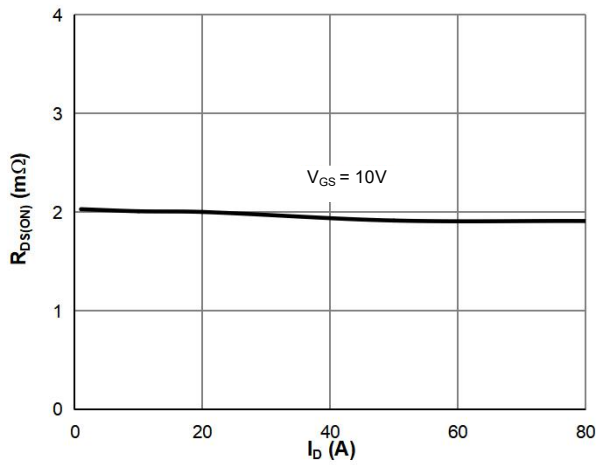
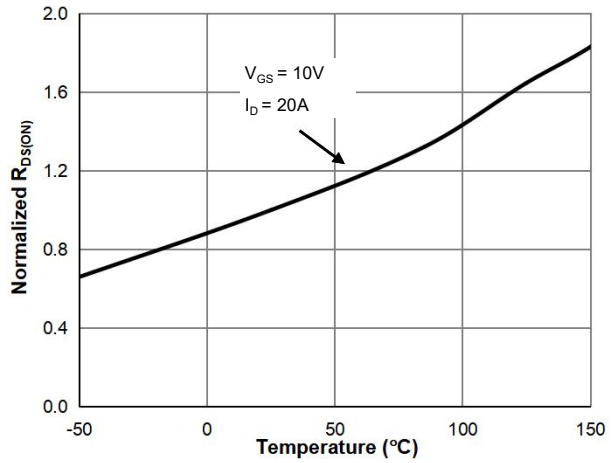
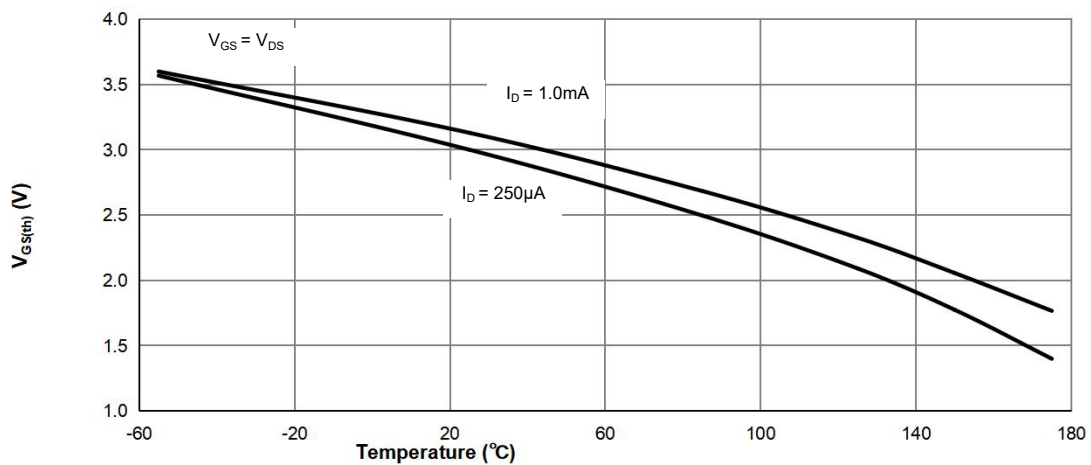
Typical Electrical & Thermal Characteristics

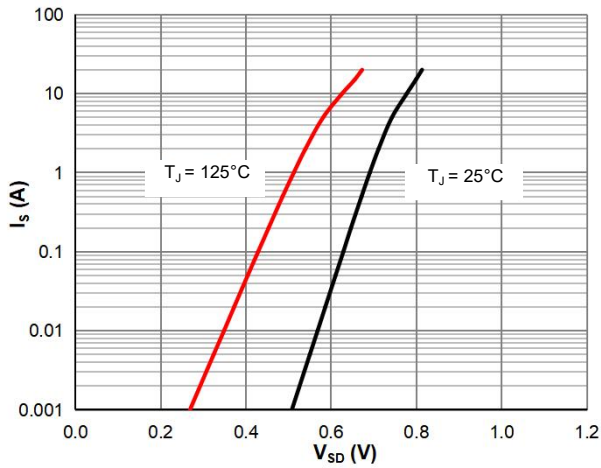
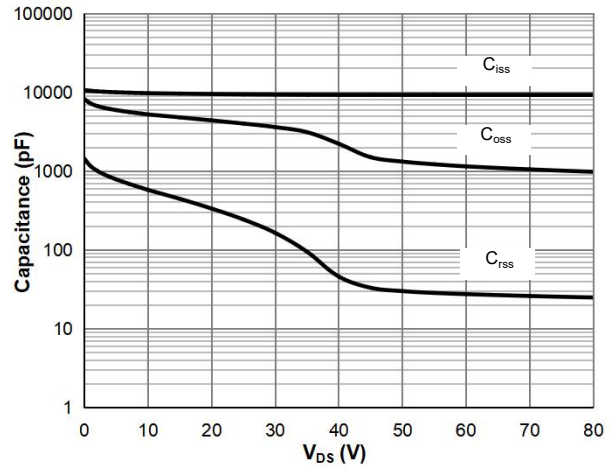
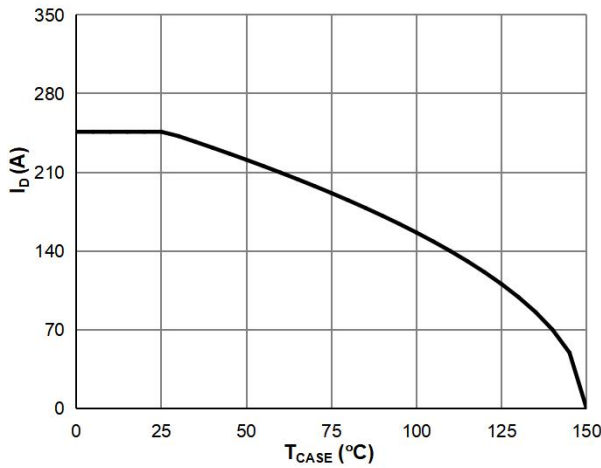
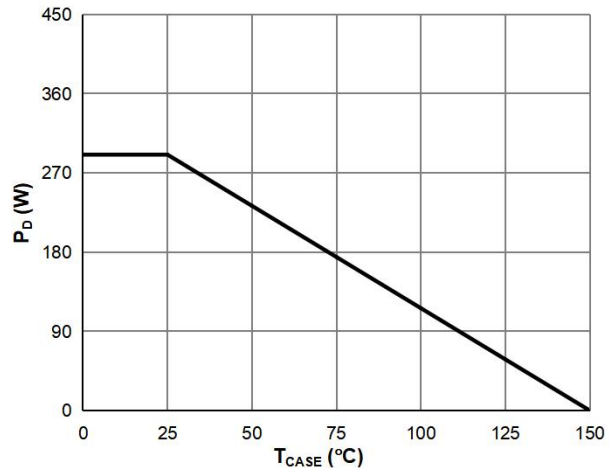
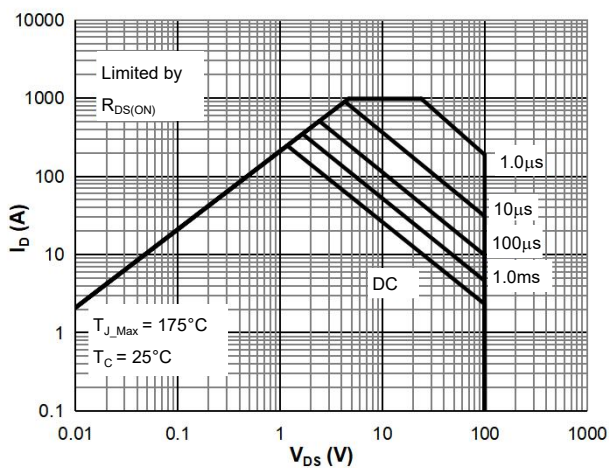
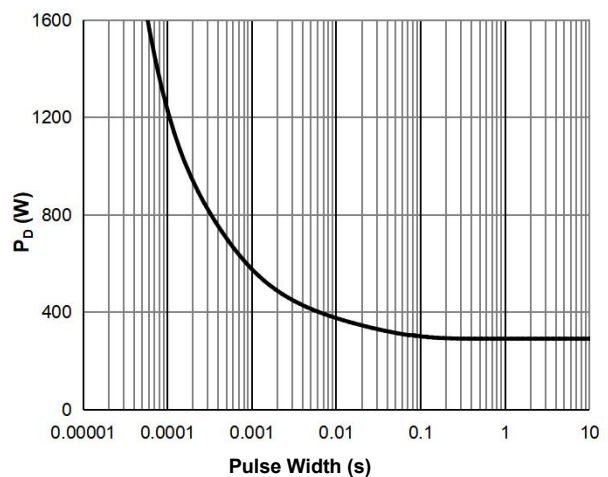
Figure 1: Saturation Characteristics

Figure 2: Transfer Characteristics

Figure 3: $R_{DS(ON)}$ vs. Drain Current

Figure 4: $R_{DS(ON)}$ vs. Junction Temperature

Figure 5: $V_{GS(th)}$ vs. Junction Temperature

Typical Electrical & Thermal Characteristics

Figure 7: Body-Diode Characteristics

Figure 8: Capacitance Characteristics

Figure 9: Current De-rating

Figure 10: Power De-rating

Figure 11: Maximum Safe Operating Area

Figure 12: Single Pulse Power Rating, Junction-to-Case

Typical Electrical & Thermal Characteristics

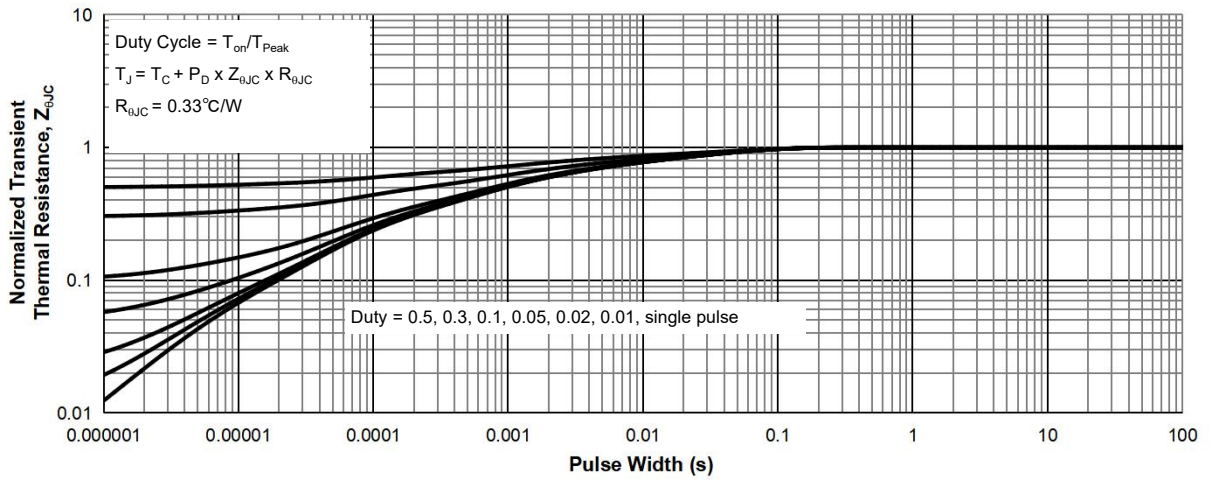
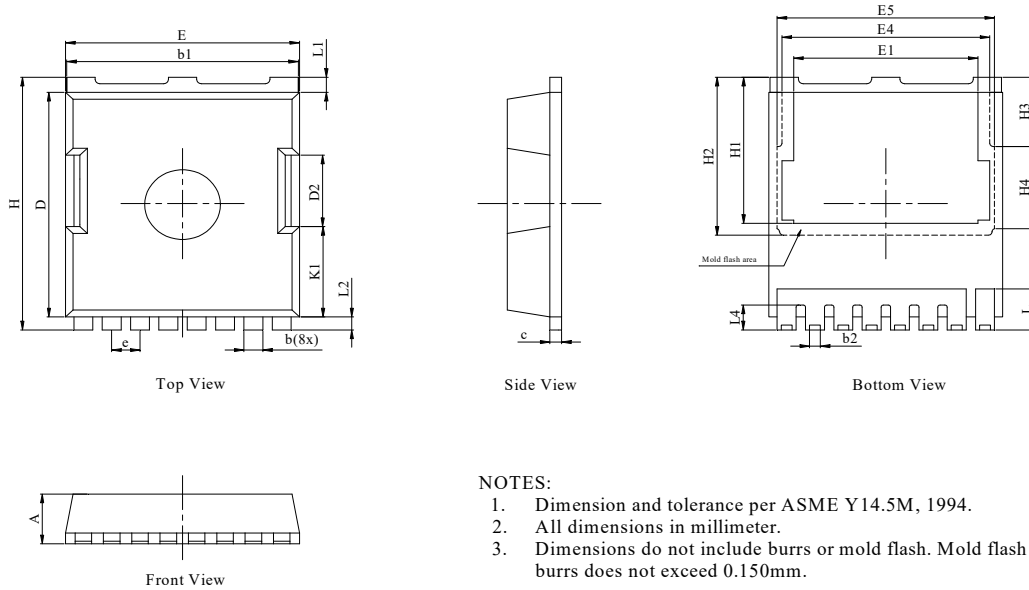

Figure 13: Normalized Maximum Transient Thermal Impedance

PowerJE[®] 10x12 Package Information
Package Outlines

NOTES:

1. Dimension and tolerance per ASME Y14.5M, 1994.
2. All dimensions in millimeter.
3. Dimensions do not include burrs or mold flash. Mold flash or burrs does not exceed 0.150mm.

DIM.	MILLIMETER		
	MIN.	NOM.	MAX.
A	2.20	2.30	2.40
b	0.70	0.80	0.90
b1	9.70	9.80	9.90
b2	0.42	0.46	0.50
c	0.40	0.50	0.60
D	10.28	10.38	10.58
D2		3.30	
E	9.70	9.90	10.10
E1		7.80	
E4		8.80	
E5		9.20	
e		1.20 (BSC)	
H	11.48	11.68	11.88
H1	6.55	6.75	6.85
H2		7.30	
H3		3.20	
H4		3.80	
K1		4.18	
L	1.70	1.90	2.10
L1		0.70	
L2		0.60	
L4	1.00	1.15	1.30

Recommended Soldering Footprint
