



## 60V 7.5mΩ N-Ch Power MOSFET

### Features

- Low  $R_{DS(ON)}$
- Low Gate Charge
- 100% UIS Tested, 100%  $R_g$  Tested
- Pb-free Lead Plating
- Halogen-free and RoHS-compliant

### Product Summary

Parameter	Value	Unit
$V_{DS}$	60	V
$V_{GS(th)}_{Typ}$	1.7	V
$I_D$ (@ $V_{GS} = 10V$ ) <sup>(1)</sup>	13.6	A
$R_{DS(ON)}_{Typ}$ (@ $V_{GS} = 10V$ )	7.5	mΩ
$R_{DS(ON)}_{Typ}$ (@ $V_{GS} = 4.5V$ )	9.5	mΩ

### Applications

- Power Management in Computing, CE, IE 4.0, Communications
- Current Switching in DC/DC & AC/DC (SR) Sub-systems
- Load Switching, Quick/Wireless Charging, Motor Driving

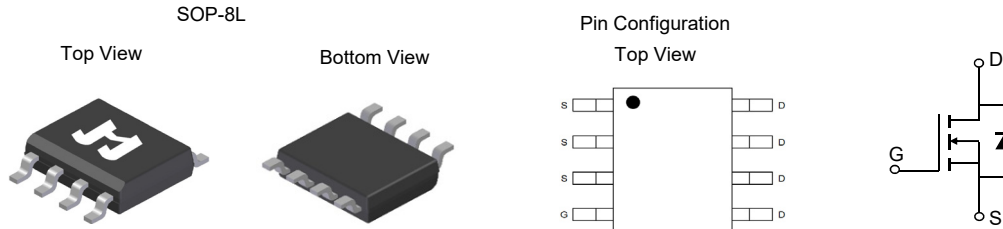

### Ordering Information

Device	Package	# of Pins	Marking	MSL	$T_J$ (°C)	Media	Quantity (pcs)
JMSL0609AP-13	SOP-8L	8	SL0609A	3	-55 to 150	13-inch Reel	2500

### Absolute Maximum Ratings (@ $T_A = 25^\circ C$ unless otherwise specified)

Parameter	Symbol	Value	Unit
Drain-to-Source Voltage	$V_{DS}$	60	V
Gate-to-Source Voltage	$V_{GS}$	±20	V
Continuous Drain Current <sup>(1)</sup>	$I_D$	$T_A = 25^\circ C$	13.6
		$T_A = 70^\circ C$	10.9
Pulsed Drain Current <sup>(2)</sup>	$I_{DM}$	39	A
Avalanche Current <sup>(3)</sup>	$I_{AS}$	26	A
Avalanche Energy <sup>(3)</sup>	$E_{AS}$	34	mJ
Power Dissipation <sup>(4)</sup>	$P_D$	$T_A = 25^\circ C$	3.1
		$T_A = 70^\circ C$	2.0
Junction & Storage Temperature Range	$T_J, T_{STG}$	-55 to 150	°C

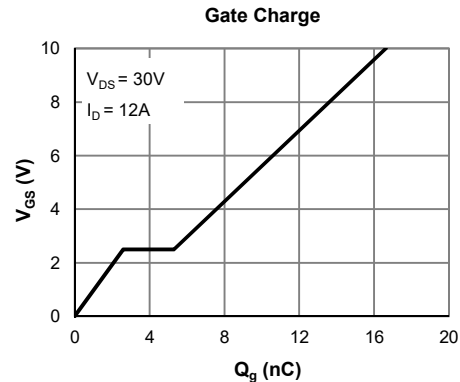
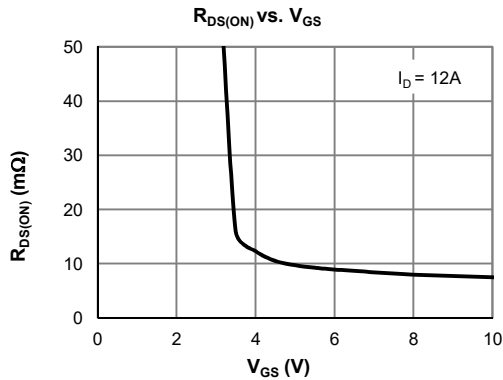

**Electrical Characteristics** (@  $T_J = 25^\circ\text{C}$  unless otherwise specified)

Parameter	Symbol	Conditions	Min.	Typ.	Max.	Unit
<b>STATIC PARAMETERS</b>						
Drain-Source Breakdown Voltage	$V_{(BR)DSS}$	$I_D = 250\mu\text{A}$ , $V_{GS} = 0\text{V}$	60			V
Zero Gate Voltage Drain Current	$I_{DSS}$	$V_{DS} = 48\text{V}$ , $V_{GS} = 0\text{V}$			1.0	$\mu\text{A}$
					5.0	
Gate-Body Leakage Current	$I_{GSS}$	$V_{DS} = 0\text{V}$ , $V_{GS} = \pm 20\text{V}$			$\pm 100$	nA
Gate Threshold Voltage	$V_{GS(th)}$	$V_{DS} = V_{GS}$ , $I_D = 250\mu\text{A}$	1.2	1.7	2.5	V
Static Drain-Source ON-Resistance	$R_{DS(on)}$	$V_{GS} = 10\text{V}$ , $I_D = 12\text{A}$		7.5	9.5	m $\Omega$
			$V_{GS} = 4.5\text{V}$ , $I_D = 6\text{A}$		9.5	
Forward Transconductance	$g_{FS}$	$V_{DS} = 5\text{V}$ , $I_D = 12\text{A}$		50		S
Diode Forward Voltage	$V_{SD}$	$I_S = 1\text{A}$ , $V_{GS} = 0\text{V}$		0.72	1.0	V
Diode Continuous Current	$I_S$	$T_C = 25^\circ\text{C}$			3.1	A
<b>DYNAMIC PARAMETERS</b> <sup>(5)</sup>						
Input Capacitance	$C_{iss}$	$V_{GS} = 0\text{V}$ , $V_{DS} = 30\text{V}$ , $f = 1\text{MHz}$		1083		pF
Output Capacitance	$C_{oss}$			349		pF
Reverse Transfer Capacitance	$C_{rss}$			8.5		pF
Gate Resistance	$R_g$	$V_{GS} = 0\text{V}$ , $V_{DS} = 0\text{V}$ , $f = 1\text{MHz}$		1.6		$\Omega$
<b>SWITCHING PARAMETERS</b> <sup>(5)</sup>						
Total Gate Charge (@ $V_{GS} = 10\text{V}$ )	$Q_g$	$V_{GS} = 0$ to $10\text{V}$ $V_{DS} = 30\text{V}$ , $I_D = 12\text{A}$		17.2		nC
Total Gate Charge (@ $V_{GS} = 4.5\text{V}$ )	$Q_g$			8.5		nC
Gate Source Charge	$Q_{gs}$			2.1		nC
Gate Drain Charge	$Q_{gd}$			2.6		nC
Turn-On Delay Time	$t_{D(on)}$			4.8		ns
Turn-On Rise Time	$t_r$	$V_{GS} = 10\text{V}$ , $V_{DS} = 30\text{V}$ $R_L = 2.5\Omega$ , $R_{GEN} = 6\Omega$		7.0		ns
Turn-Off Delay Time	$t_{D(off)}$			21.5		ns
Turn-Off Fall Time	$t_f$			9.0		ns
Body Diode Reverse Recovery Time	$t_{rr}$	$I_F = 12\text{A}$ , $dI_F/dt = 100\text{A}/\mu\text{s}$		26		ns
Body Diode Reverse Recovery Charge	$Q_{rr}$	$I_F = 12\text{A}$ , $dI_F/dt = 100\text{A}/\mu\text{s}$		13.5		nC

**Thermal Performance**

Parameter	Symbol	Typ.	Max.	Unit
Thermal Resistance, Junction-to-Ambient ( $t \leq 10\text{s}$ )	$R_{\theta JA}$	30	40	$^\circ\text{C}/\text{W}$
Thermal Resistance, Junction-to-Ambient (steady state)	$R_{\theta JA}$	60	70	$^\circ\text{C}/\text{W}$

**Notes:**

1. Computed continuous current assumes the condition of  $T_{J\_Max}$  while the actual continuous current depends on the thermal & electro-mechanical application board design.
2. This single-pulse measurement was taken under  $T_{J\_Max} = 150^\circ\text{C}$ .
3. This single-pulse measurement was taken under the following condition [ $L = 100\mu\text{H}$ ,  $V_{GS} = 10\text{V}$ ,  $V_{DS} = 30\text{V}$ ] while its value is limited by  $T_{J\_Max} = 150^\circ\text{C}$ .
4. The power dissipation  $P_D$  is based on  $T_{J\_Max} = 150^\circ\text{C}$ .
5. This value is guaranteed by design hence it is not included in the production test.

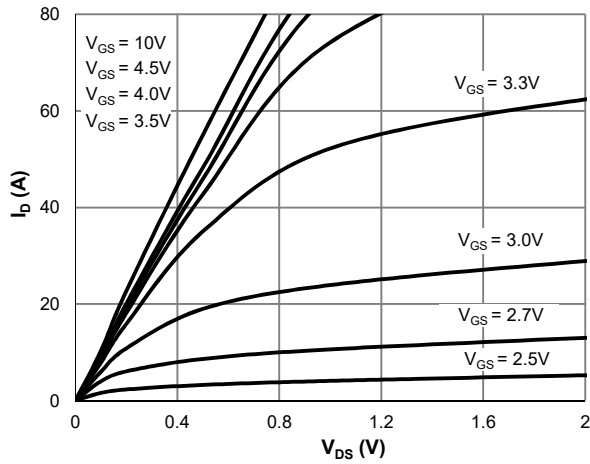
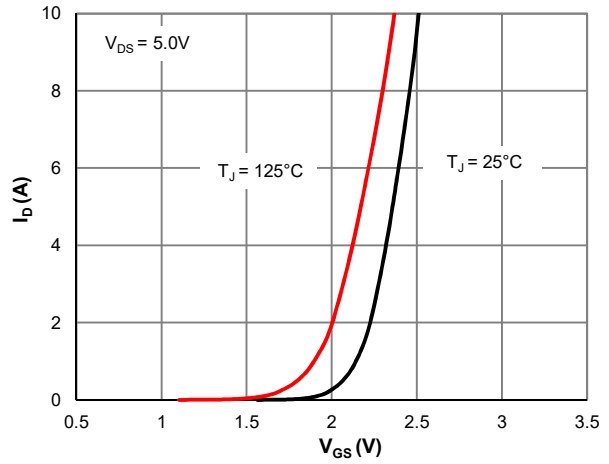
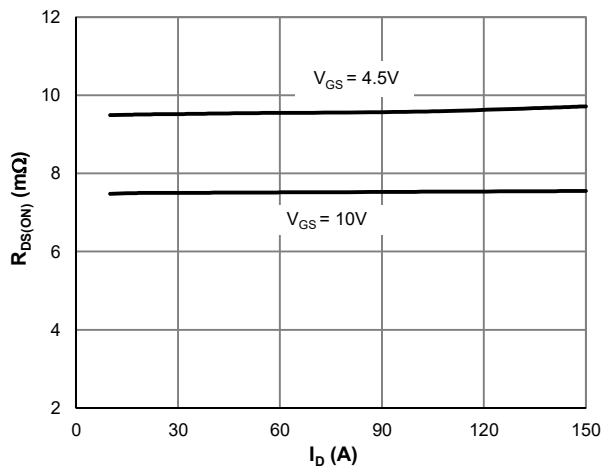
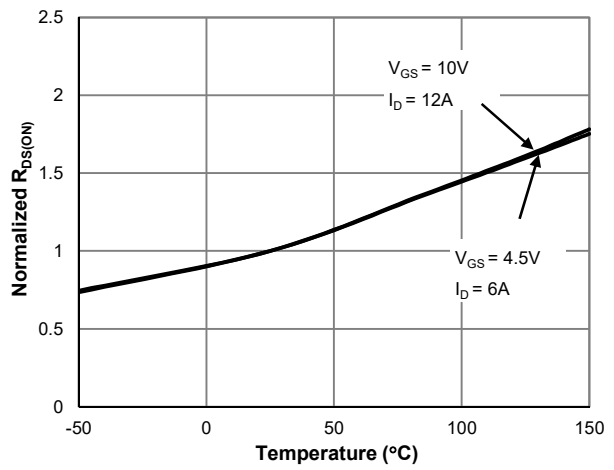
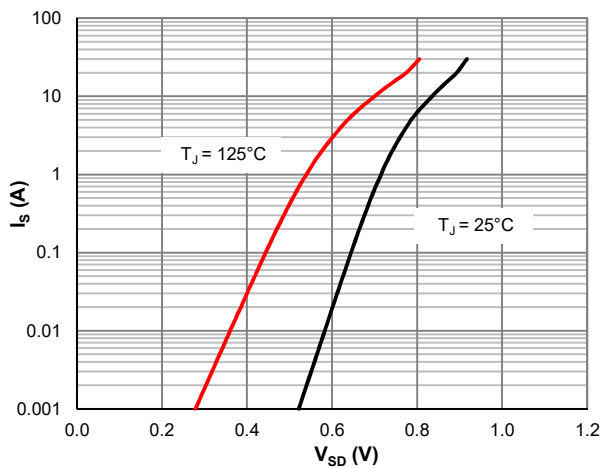
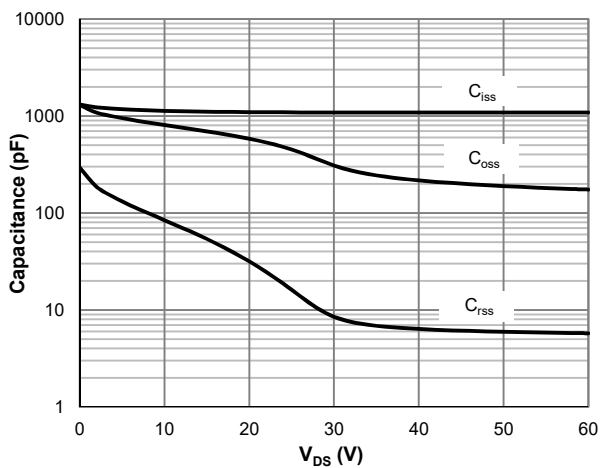
**Typical Electrical & Thermal Characteristics**

**Figure 1: Saturation Characteristics**

**Figure 2: Transfer Characteristics**

**Figure 3:  $R_{DS(ON)}$  vs. Drain Current**

**Figure 4:  $R_{DS(ON)}$  vs. Junction Temperature**

**Figure 5: Body-Diode Characteristics**

**Figure 6: Capacitance Characteristics**

Typical Electrical & Thermal Characteristics

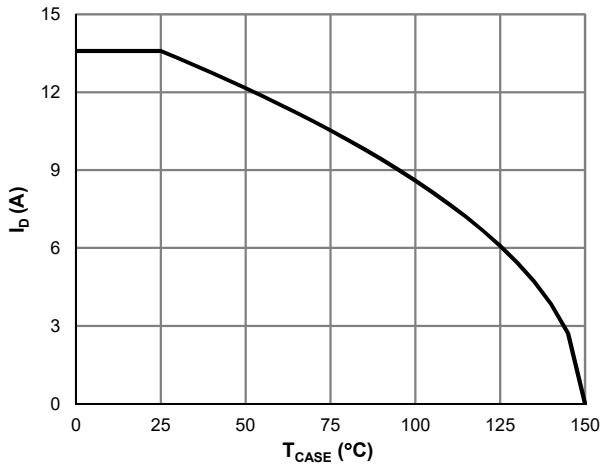

Figure 7: Current De-rating

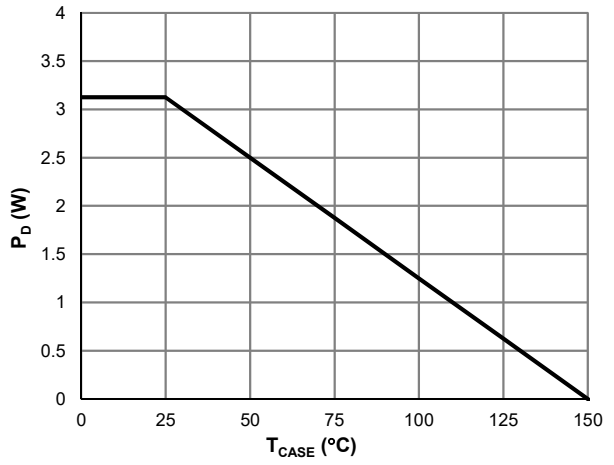

Figure 8: Power De-rating

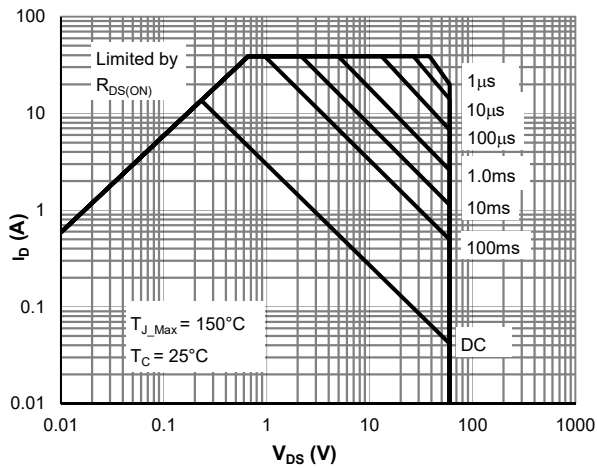

Figure 9: Maximum Safe Operating Area

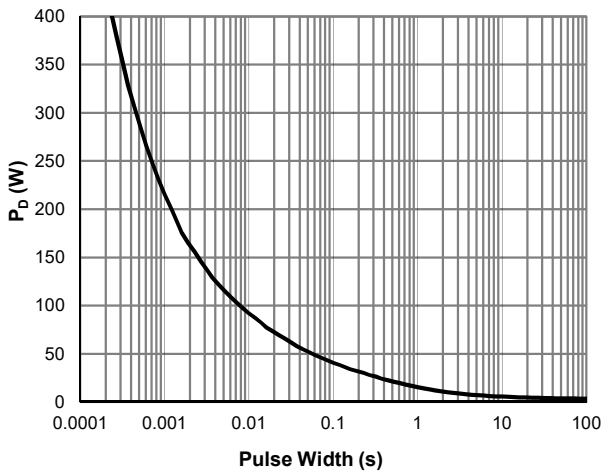

Figure 10: Single Pulse Power Rating, Junction-to-Case

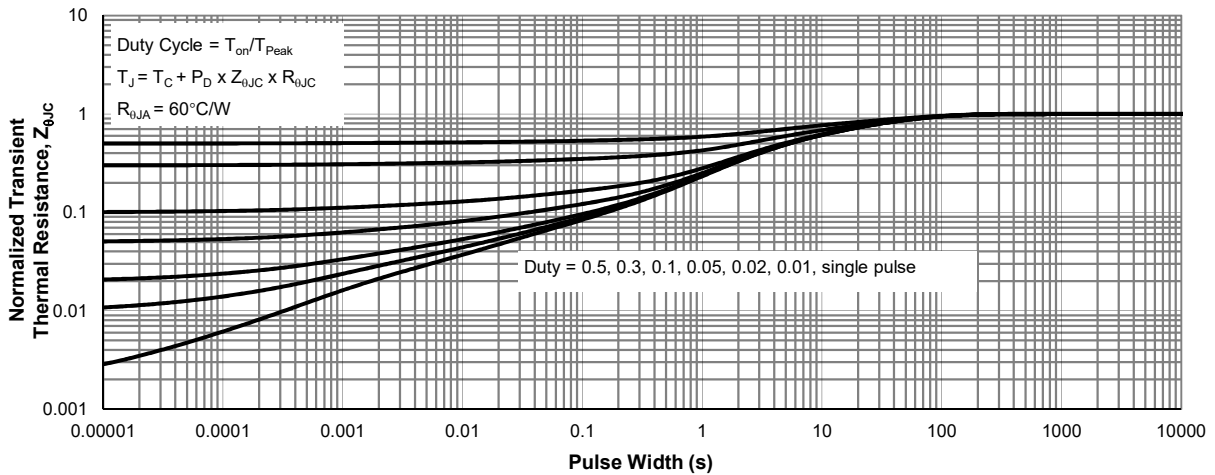
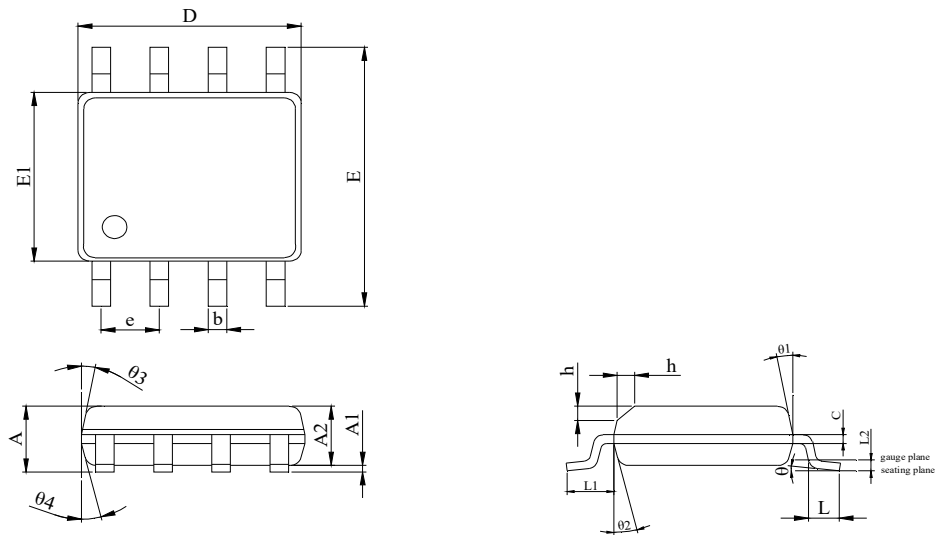

Figure 11: Normalized Maximum Transient Thermal Impedance

**SOP-8L Package Information**
**Package Outline**

DIM	MILLIMETER		
	MIN.	NOM.	MAX.
A	1.35	1.50	1.65
A1	0.05	0.10	0.15
A2	1.35	1.40	1.50
b	0.38	--	0.50
c	0.17	--	0.25
D	4.80	4.90	5.00
E	5.80	6.00	6.20
E1	3.80	3.90	4.00
e	1.27(BSC)		
L	0.45	0.60	0.80
L1	1.04 REF		
L2	0.25 BSC		
h	0.30	0.40	0.50
$\theta$	0°	--	8°
$\theta_1$	10°	12°	14°
$\theta_2$	8°	10°	12°
$\theta_3$	10°	12°	14°
$\theta_4$	8°	10°	12°

**Recommended Soldering Footprint**
