



200V 8.0mΩ N-Ch Power MOSFET

Features

- Ultra-low ON-resistance, $R_{DS(ON)}$
- Low Gate Charge, Q_g
- 100% UIS and R_g Tested
- Pb-free Lead Plating
- Halogen-free and RoHS-compliant

Product Summary

Parameter	Value	Unit
V_{DS}	200	V
$V_{GS(th_Typ)}$	3.0	V
I_D (@ $V_{GS} = 10V$) ⁽¹⁾	122	A
$R_{DS(ON_Typ)}$ (@ $V_{GS} = 10V$)	8.0	mΩ

Applications

- Power Management in Computing, CE, IE 4.0, Communications
- Current Switching in DC/DC & AC/DC (SR) Sub-systems
- Load Switching, Quick/Wireless Charging, Motor Driving

TO-247-3L Top View

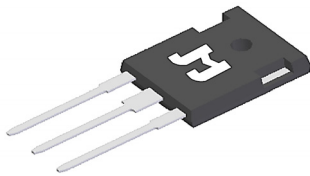

TO-247-3L Bottom View

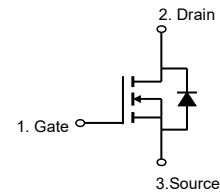
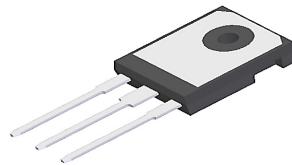

Ordering Information

Device	Package	# of Pins	Marking	MSL	T_J (°C)	Media	Quantity (pcs)
JMSH2010PS-U	TO-247-3L	3	SH2010P	NA	-55 to 150	Tube	30

Absolute Maximum Ratings (@ $T_A = 25^\circ C$ unless otherwise specified)

Parameter	Symbol	Value	Unit
Drain-to-Source Voltage	V_{DS}	200	V
Gate-to-Source Voltage	V_{GS}	±20	V
Continuous Drain Current ⁽¹⁾	I_D	$T_C = 25^\circ C$	122
		$T_C = 100^\circ C$	77
Pulsed Drain Current ⁽²⁾	I_{DM}	233	A
Avalanche Energy ⁽³⁾	E_{AS}	1094	mJ
Power Dissipation ⁽⁴⁾	P_D	$T_C = 25^\circ C$	367
		$T_C = 100^\circ C$	147
Junction & Storage Temperature Range	T_J, T_{STG}	-55 to 150	°C

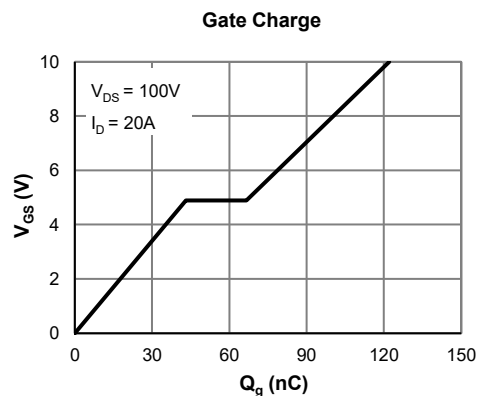
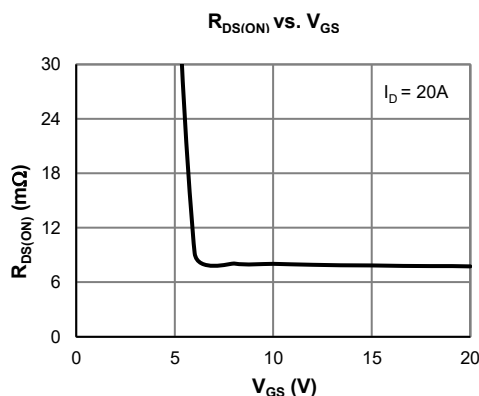

**Electrical Characteristics** (@ $T_J = 25^\circ\text{C}$ unless otherwise specified)

Parameter	Symbol	Conditions	Min.	Typ.	Max.	Unit	
STATIC PARAMETERS							
Drain-Source Breakdown Voltage	$V_{(BR)DSS}$	$I_D = 250\mu\text{A}$, $V_{GS} = 0\text{V}$	200			V	
Zero Gate Voltage Drain Current	I_{DSS}	$V_{DS} = 160\text{V}$, $V_{GS} = 0\text{V}$			1.0	μA	
					5.0		
Gate-Body Leakage Current	I_{GSS}	$V_{DS} = 0\text{V}$, $V_{GS} = \pm 20\text{V}$			± 100	nA	
Gate Threshold Voltage	$V_{GS(th)}$	$V_{DS} = V_{GS}$, $I_D = 250\mu\text{A}$	2.0	3.0	4.0	V	
Static Drain-Source ON-Resistance	$R_{DS(ON)}$	$V_{GS} = 10\text{V}$, $I_D = 20\text{A}$		8.0	9.6	$\text{m}\Omega$	
Forward Transconductance	g_{FS}	$V_{DS} = 5\text{V}$, $I_D = 20\text{A}$		57		S	
Diode Forward Voltage	V_{SD}	$I_S = 1\text{A}$, $V_{GS} = 0\text{V}$		0.70	1.0	V	
Diode Continuous Current	I_S	$T_C = 25^\circ\text{C}$			122	A	
DYNAMIC PARAMETERS ⁽⁵⁾							
Input Capacitance	C_{iss}	$V_{GS} = 0\text{V}$, $V_{DS} = 100\text{V}$, $f = 1\text{MHz}$		8788		pF	
Output Capacitance	C_{oss}				455		pF
Reverse Transfer Capacitance	C_{rss}				17.1		pF
Gate Resistance	R_g	$V_{GS} = 0\text{V}$, $V_{DS} = 0\text{V}$, $f = 1\text{MHz}$		4.7		Ω	
SWITCHING PARAMETERS ⁽⁵⁾							
Total Gate Charge (@ $V_{GS} = 10\text{V}$)	Q_g	$V_{GS} = 0$ to 10V $V_{DS} = 100\text{V}$, $I_D = 20\text{A}$		122		nC	
Total Gate Charge (@ $V_{GS} = 6\text{V}$)	Q_g			79		nC	
Gate Source Charge	Q_{gs}			43		nC	
Gate Drain Charge	Q_{gd}			23		nC	
Turn-On DelayTime	$t_{D(on)}$	$V_{GS} = 10\text{V}$, $V_{DS} = 100\text{V}$ $R_L = 5\Omega$, $R_{GEN} = 3\Omega$		30		ns	
Turn-On Rise Time	t_r			58		ns	
Turn-Off DelayTime	$t_{D(off)}$			98		ns	
Turn-Off Fall Time	t_f			43		ns	
Body Diode Reverse Recovery Time	t_{rr}		$I_F = 20\text{A}$, $dI_F/dt = 100\text{A}/\mu\text{s}$		186		ns
Body Diode Reverse Recovery Charge	Q_{rr}	$I_F = 20\text{A}$, $dI_F/dt = 100\text{A}/\mu\text{s}$		743		nC	

Thermal Performance

Parameter	Symbol	Typ.	Max.	Unit
Thermal Resistance, Junction-to-Ambient	$R_{\theta JA}$	49	59	$^\circ\text{C}/\text{W}$
Thermal Resistance, Junction-to-Case	$R_{\theta JC}$	0.34	0.41	$^\circ\text{C}/\text{W}$

Notes:

1. Computed continuous current assumes the condition of T_{J_Max} while the actual continuous current depends on the thermal & electro-mechanical application board design.
2. This single-pulse measurement was taken under $T_{J_Max} = 150^\circ\text{C}$.
3. E_{AS} of 1094 mJ is based on starting $T_J = 25^\circ\text{C}$, $L = 3.0\text{mH}$, $I_{AS} = 27\text{A}$, $V_{GS} = 10\text{V}$, $V_{DD} = 100\text{V}$; 100% test at $L = 0.3\text{mH}$, $I_{AS} = 56\text{A}$.
4. The power dissipation P_D is based on $T_{J_Max} = 150^\circ\text{C}$.
5. This value is guaranteed by design hence it is not included in the production test.

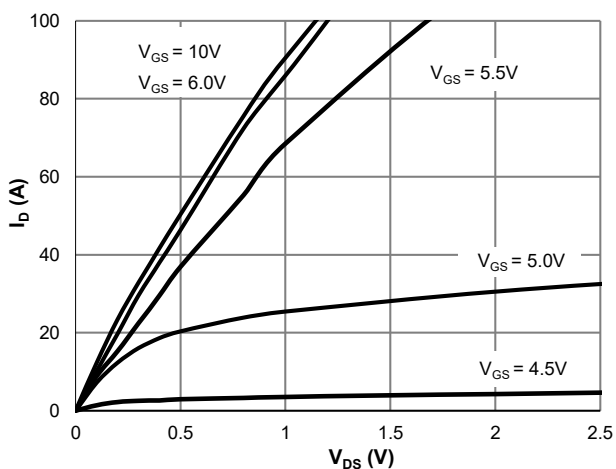
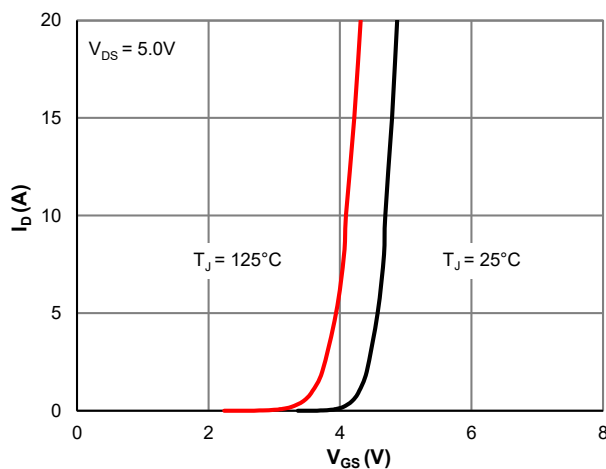
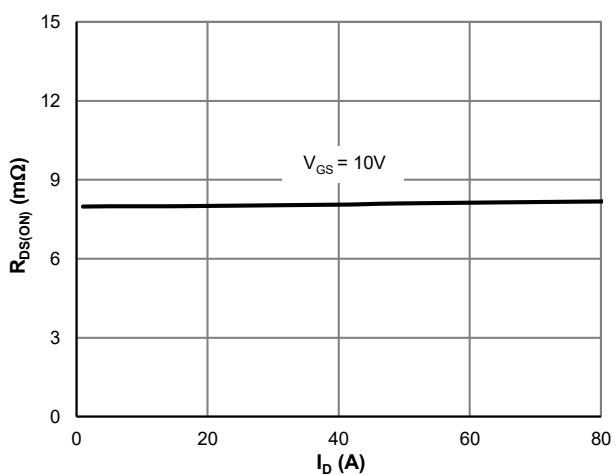
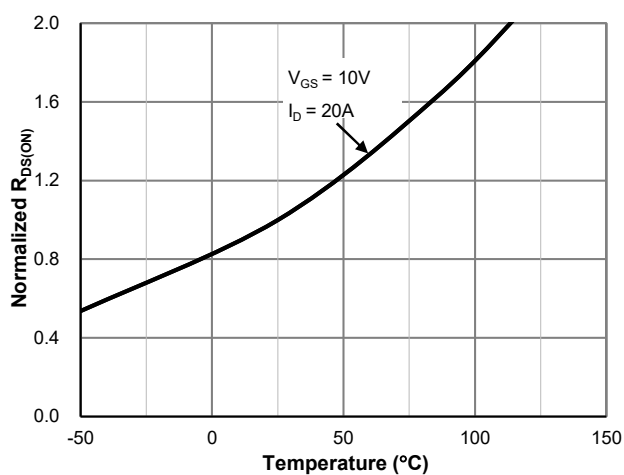
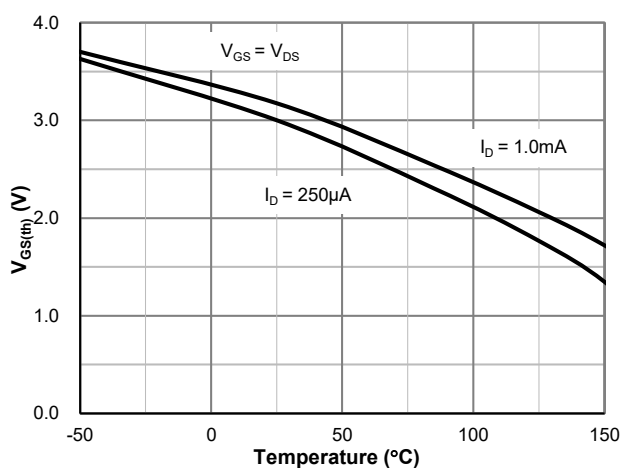
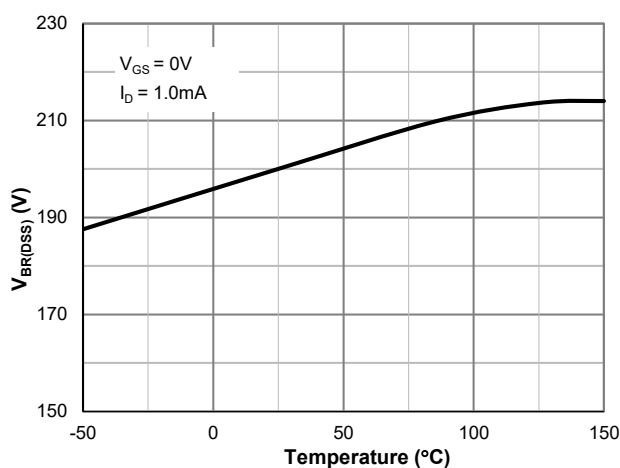
Typical Electrical & Thermal Characteristics

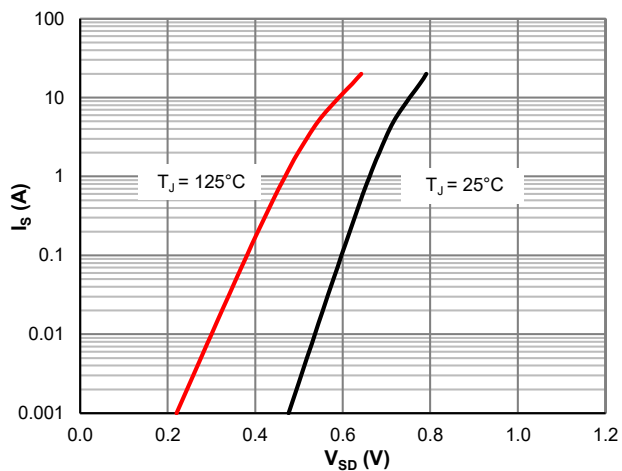
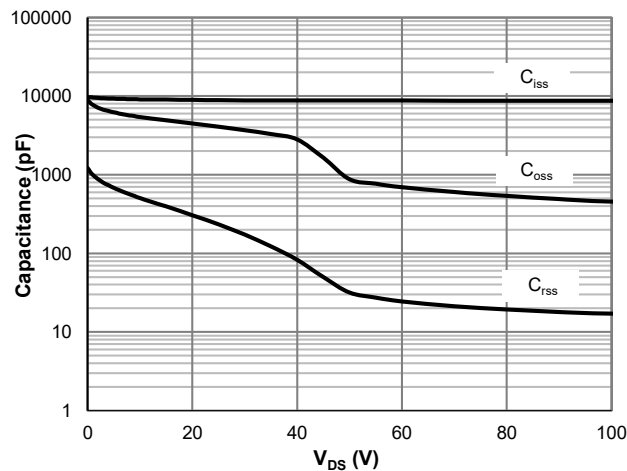
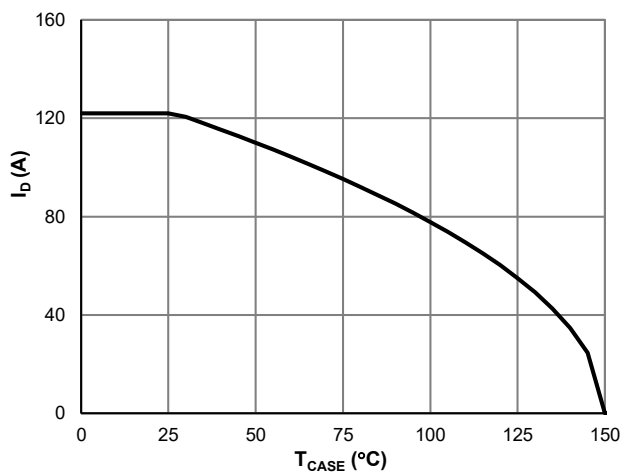
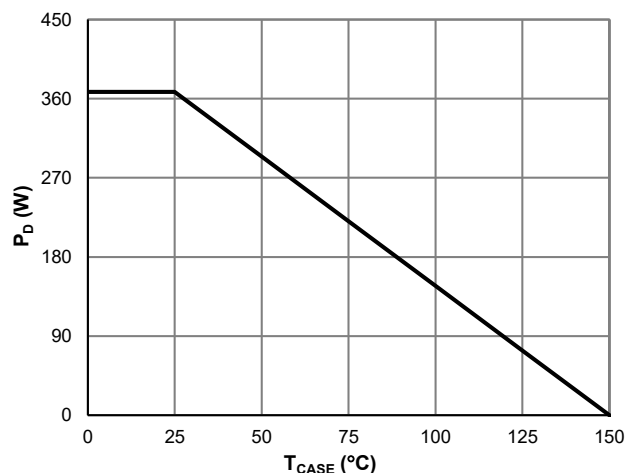
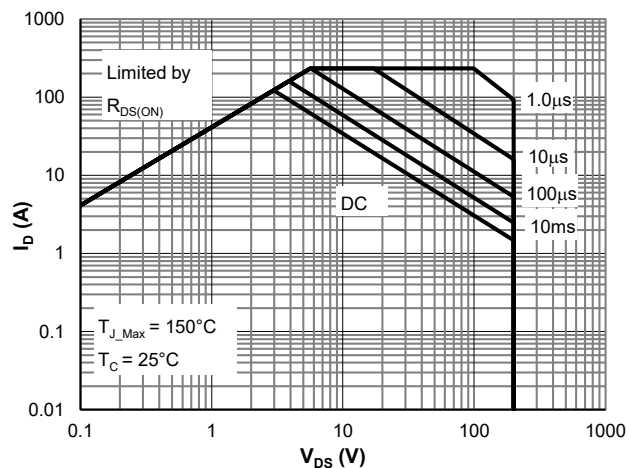
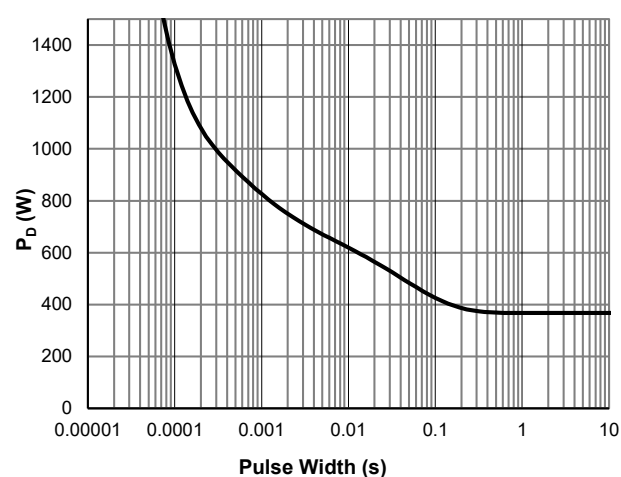
Figure 1: Saturation Characteristics

Figure 2: Transfer Characteristics

Figure 3: $R_{DS(ON)}$ vs. Drain Current

Figure 4: $R_{DS(ON)}$ vs. Junction Temperature

Figure 5: $V_{GS(th)}$ vs. Junction Temperature

Figure 6: $V_{BR(DSS)}$ vs. Junction Temperature

Typical Electrical & Thermal Characteristics

Figure 7: Body-Diode Characteristics

Figure 8: Capacitance Characteristics

Figure 9: Current De-rating

Figure 10: Power De-rating

Figure 11: Maximum Safe Operating Area

Figure 12: Single Pulse Power Rating, Junction-to-Case



Typical Electrical & Thermal Characteristics

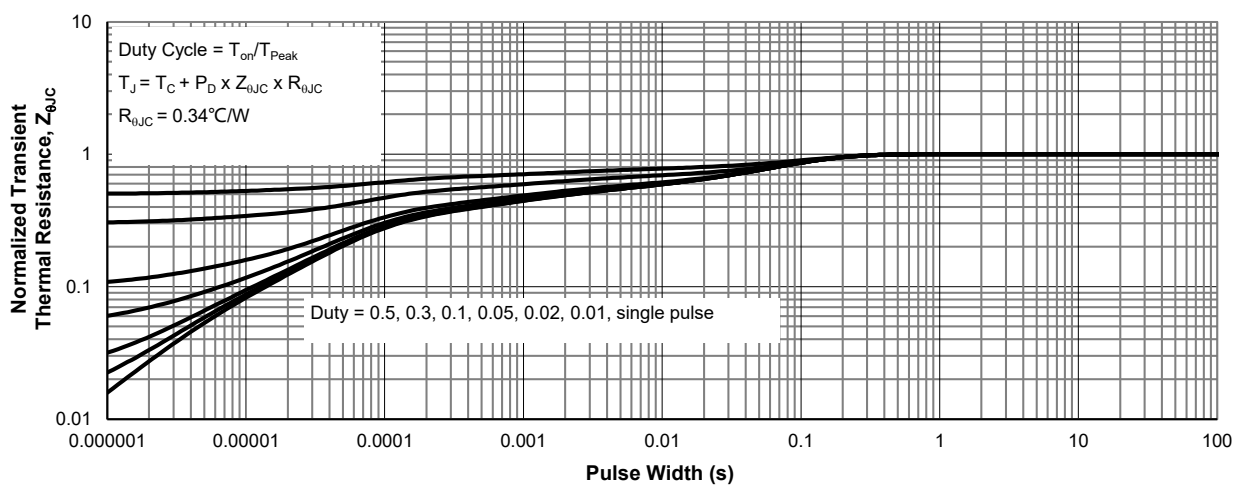
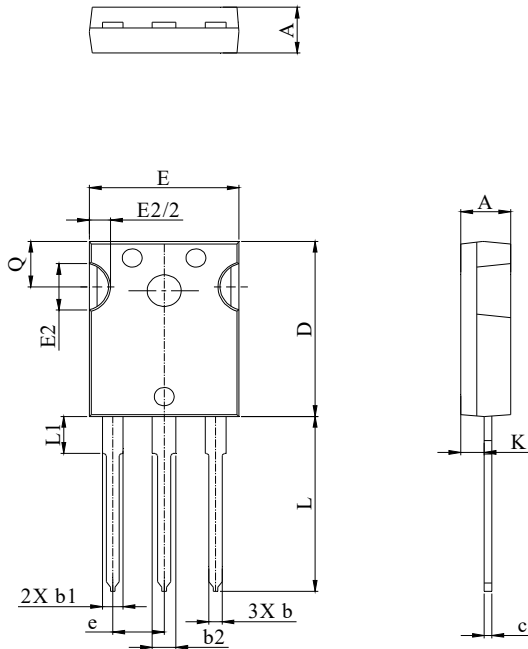
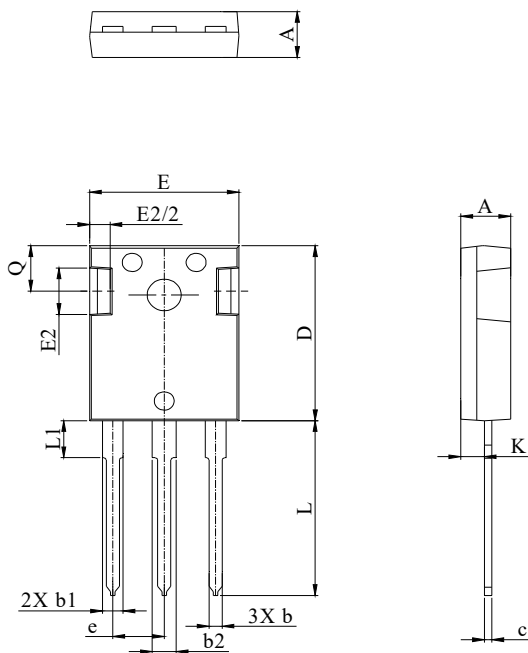

Figure 13: Normalized Maximum Transient Thermal Impedance

TO-247-3L Package Information
Type_A Package Outline

DIM.	MILLIMETER		
	MIN.	NOM.	MAX.
A	4.80	5.02	5.21
b	1.00	1.20	1.40
b1	1.90	2.00	2.39
b2	2.87	3.00	3.22
c	0.41	0.60	0.79
D	20.80	21.00	21.20
E	15.50	15.94	16.13
E2	4.32		5.49
L	19.70	20.07	20.32
L1	4.00		4.40
K	2.20		2.50
e	5.44 BSC		

Type_B Package Outline

DIM.	MILLIMETER		
	MIN.	NOM.	MAX.
A	4.80	5.02	5.21
b	1.00	1.20	1.40
b1	1.90	2.00	2.39
b2	2.87	3.00	3.22
c	0.41	0.60	0.79
D	20.80	21.00	21.20
E	15.50	15.94	16.13
E2	4.32		5.49
L	19.70	20.07	20.32
L1	4.00		4.40
K	2.20		2.50
e	5.44 BSC		