



150V 4.0mΩ N-Ch Power MOSFET

Features

- Low ON-resistance, $R_{DS(ON)}$
- Low Gate Charge, Q_g
- 100% UIS and R_g Tested
- Pb-free Lead Plating
- Halogen-free and RoHS-compliant
- AEC-Q101 Qualified for Automotive Applications

Product Summary

| Parameter | Value | Unit |
|--|-------|------|
| V_{DS} | 150 | V |
| $V_{GS(th_Typ)}$ | 3.2 | V |
| I_D (@ $V_{GS} = 10V$) ⁽¹⁾ | 230 | A |
| $R_{DS(ON_Typ)}$ (@ $V_{GS} = 10V$) | 4.0 | mΩ |

TO-247-3L Top View

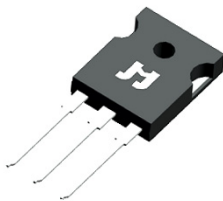

TO-247-3L Bottom View

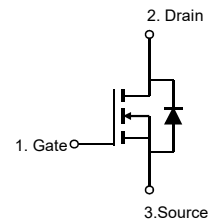

Ordering Information

| Device | Package | # of Pins | Marking | MSL | T_J (°C) | Media | Quantity (pcs) |
|---------------|-----------|-----------|---------|-----|------------|-------|----------------|
| JMSH1504ASQ-U | TO-247-3L | 3 | SH1504A | NA | -55 to 175 | Tube | 30 |

Absolute Maximum Ratings (@ $T_A = 25^\circ C$ unless otherwise specified)

| Parameter | Symbol | Value | Unit |
|---|----------------|---------------------|------|
| Drain-to-Source Voltage | V_{DS} | 150 | V |
| Gate-to-Source Voltage | V_{GS} | ±20 | V |
| Continuous Drain Current ⁽¹⁾ | I_D | $T_C = 25^\circ C$ | 230 |
| | | $T_C = 100^\circ C$ | 163 |
| Pulsed Drain Current ⁽²⁾ | I_{DM} | 920 | A |
| Avalanche Current ⁽³⁾ | I_{AS} | 77 | A |
| Avalanche Energy ⁽³⁾ | E_{AS} | 889 | mJ |
| Power Dissipation ⁽⁴⁾ | P_D | $T_C = 25^\circ C$ | 600 |
| | | $T_C = 100^\circ C$ | 300 |
| Junction & Storage Temperature Range | T_J, T_{STG} | -55 to 175 | °C |

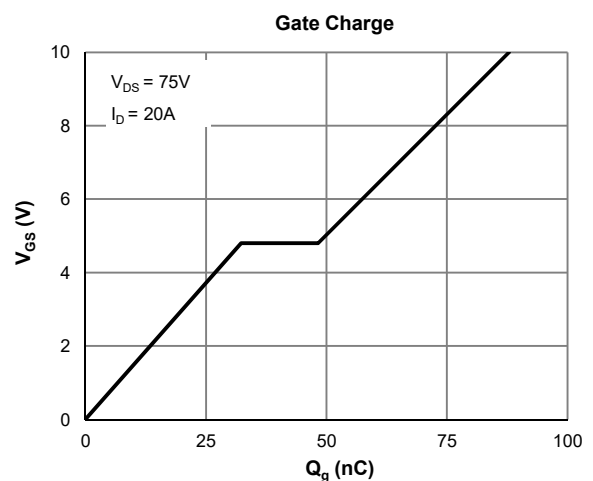
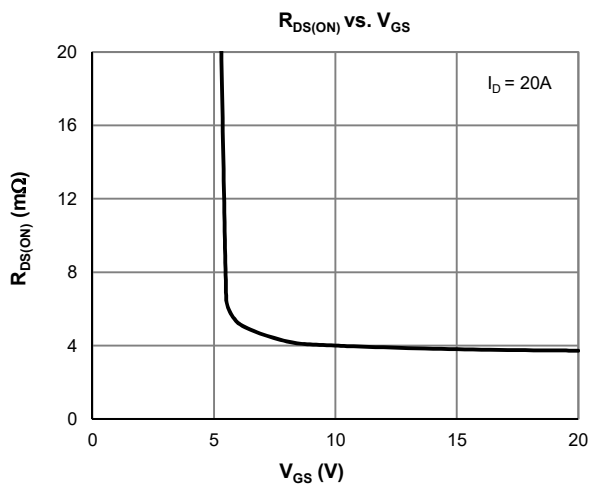



Electrical Characteristics (@ $T_J = 25^\circ\text{C}$ unless otherwise specified)

| Parameter | Symbol | Conditions | Min. | Typ. | Max. | Unit |
|-----------------------------------|---------------|---|------|------|-----------|------------------|
| STATIC PARAMETERS | | | | | | |
| Drain-Source Breakdown Voltage | $V_{(BR)DSS}$ | $I_D = 250\mu\text{A}, V_{GS} = 0\text{V}$ | 150 | | | V |
| Zero Gate Voltage Drain Current | I_{DSS} | $V_{DS} = 120\text{V}, V_{GS} = 0\text{V}$ | | | 1.0 | μA |
| | | | | | 5.0 | |
| Gate-Body Leakage Current | I_{GSS} | $V_{DS} = 0\text{V}, V_{GS} = \pm 20\text{V}$ | | | ± 100 | nA |
| Gate Threshold Voltage | $V_{GS(th)}$ | $V_{DS} = V_{GS}, I_D = 250\mu\text{A}$ | 2.5 | 3.2 | 4.5 | V |
| Static Drain-Source ON-Resistance | $R_{DS(ON)}$ | $V_{GS} = 10\text{V}, I_D = 20\text{A}$ | | 4.0 | 4.9 | $\text{m}\Omega$ |
| Forward Transconductance | g_{FS} | $V_{DS} = 5\text{V}, I_D = 20\text{A}$ | | 64 | | S |
| Diode Forward Voltage | V_{SD} | $I_S = 1\text{A}, V_{GS} = 0\text{V}$ | | 0.68 | 1.0 | V |
| Diode Continuous Current | I_S | $T_C = 25^\circ\text{C}$ | | | 600 | A |

DYNAMIC PARAMETERS ⁽⁵⁾

| | | | | | | |
|------------------------------|-----------|--|--|------|--|----------|
| Input Capacitance | C_{iss} | $V_{GS} = 0\text{V}, V_{DS} = 75\text{V}, f = 1\text{MHz}$ | | 6540 | | pF |
| Output Capacitance | C_{oss} | | | 772 | | pF |
| Reverse Transfer Capacitance | C_{rss} | | | 6.7 | | pF |
| Gate Resistance | R_g | $V_{GS} = 0\text{V}, V_{DS} = 0\text{V}, f = 1\text{MHz}$ | | 2.4 | | Ω |

SWITCHING PARAMETERS ⁽⁵⁾

| | | | | | | |
|---|--------------|--|---|------|-----|----|
| Total Gate Charge (@ $V_{GS} = 10\text{V}$) | Q_g | $V_{GS} = 0 \text{ to } 10\text{V}$ $V_{DS} = 75\text{V}, I_D = 20\text{A}$ | | 88 | | nC |
| Total Gate Charge (@ $V_{GS} = 6.0\text{V}$) | Q_g | | | 57 | | nC |
| Gate Source Charge | Q_{gs} | | | 32 | | nC |
| Gate Drain Charge | Q_{gd} | | | 16.0 | | nC |
| Turn-On DelayTime | $t_{D(on)}$ | $V_{GS} = 10\text{V}, V_{DS} = 75\text{V}$ $R_L = 3.8\Omega, R_{GEN} = 6\Omega$ | | 48 | | ns |
| Turn-On Rise Time | t_r | | | 90 | | ns |
| Turn-Off DelayTime | $t_{D(off)}$ | | | 94 | | ns |
| Turn-Off Fall Time | t_f | | | 60 | | ns |
| Body Diode Reverse Recovery Time | t_{rr} | | $I_F = 15\text{A}, dI_F/dt = 100\text{A}/\mu\text{s}$ | | 122 | |
| Body Diode Reverse Recovery Charge | Q_{rr} | $I_F = 15\text{A}, dI_F/dt = 100\text{A}/\mu\text{s}$ | | 279 | | nC |

Thermal Performance

| Parameter | Symbol | Typ. | Max. | Unit |
|---|-----------------|------|------|---------------------------|
| Thermal Resistance, Junction-to-Ambient | $R_{\theta JA}$ | 40 | 48 | $^\circ\text{C}/\text{W}$ |
| Thermal Resistance, Junction-to-Case | $R_{\theta JC}$ | 0.25 | 0.30 | $^\circ\text{C}/\text{W}$ |

Notes:

1. Computed continuous current assumes the condition of T_{J_Max} while the actual continuous current depends on the thermal & electro-mechanical application board design.
2. This single-pulse measurement was taken under $T_{J_Max} = 175^\circ\text{C}$.
3. This single-pulse measurement was taken under the following condition [$L = 300\mu\text{H}, V_{GS} = 10\text{V}, V_{DD} = 75\text{V}$] while its value is limited by $T_{J_Max} = 175^\circ\text{C}$.
4. The power dissipation P_D is based on $T_{J_Max} = 175^\circ\text{C}$.
5. This value is guaranteed by design hence it is not included in the production test.

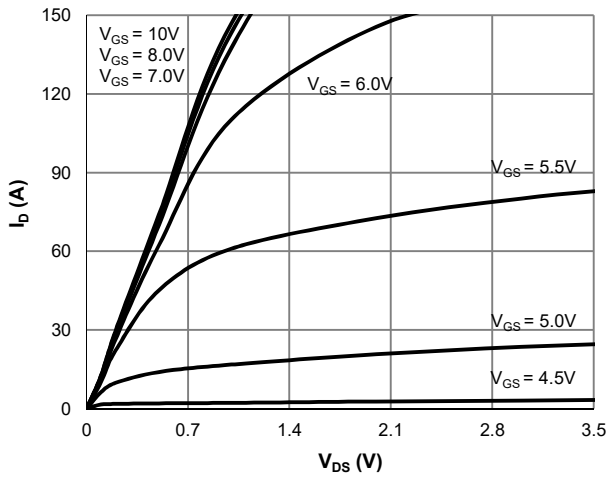
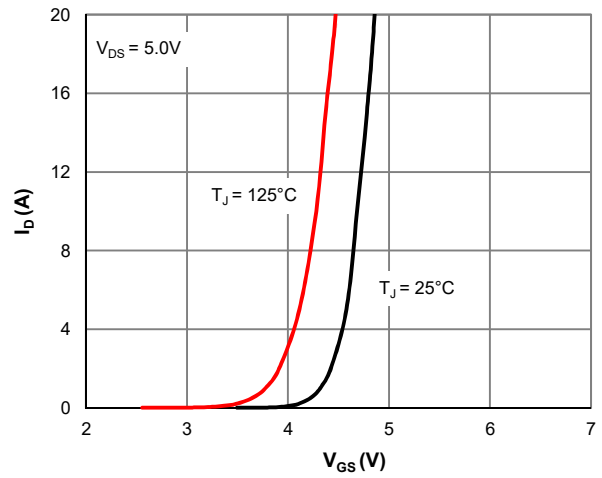
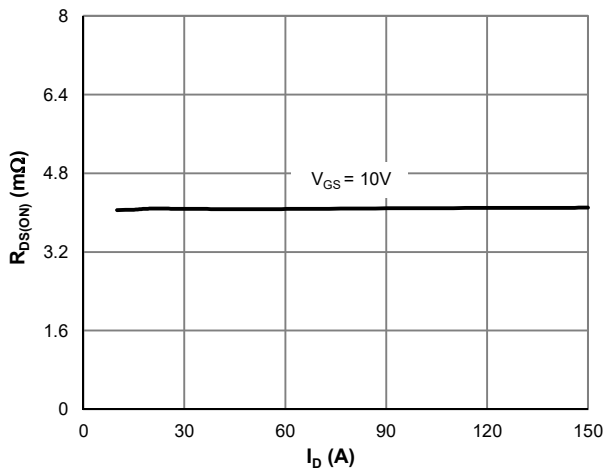
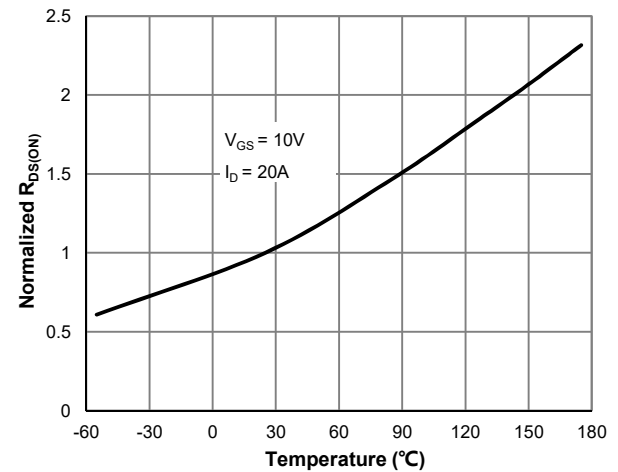
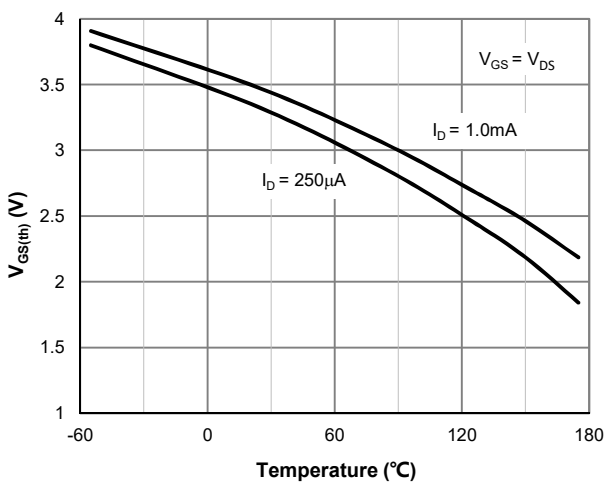
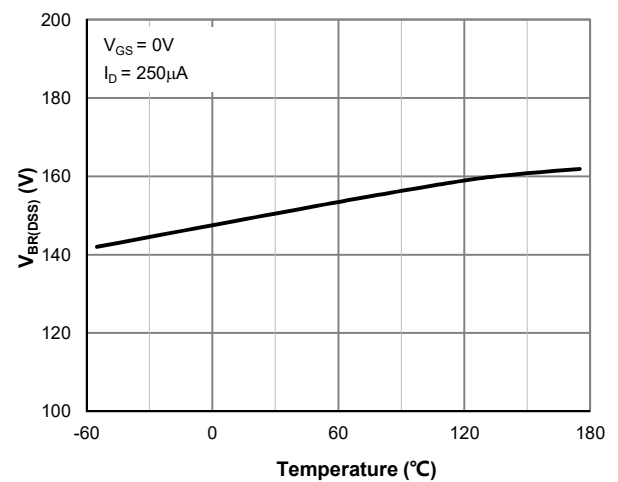
Typical Electrical & Thermal Characteristics

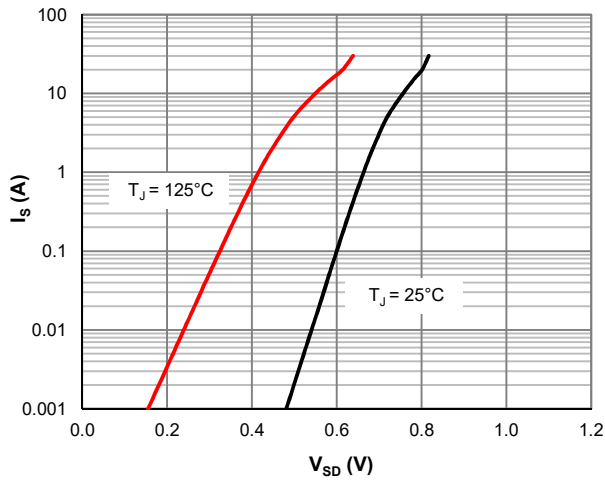
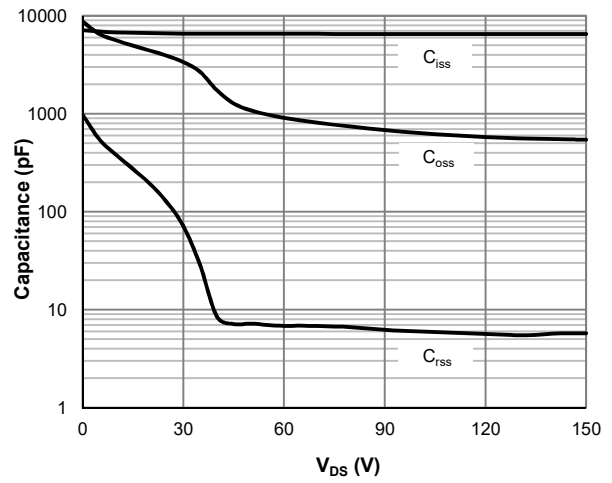
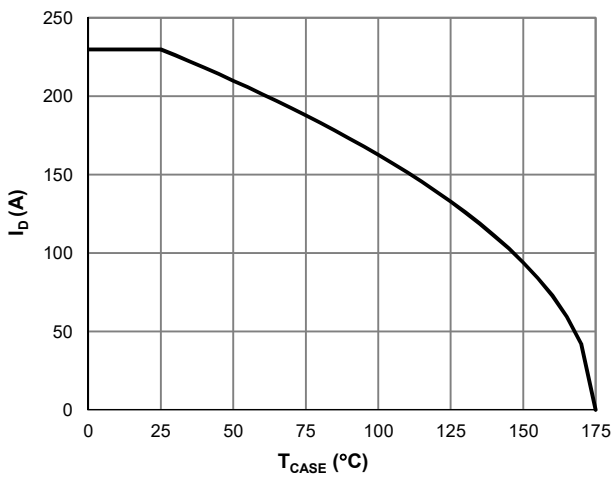
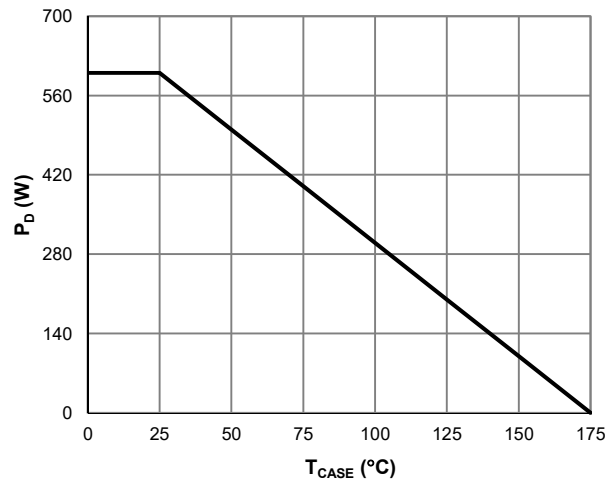
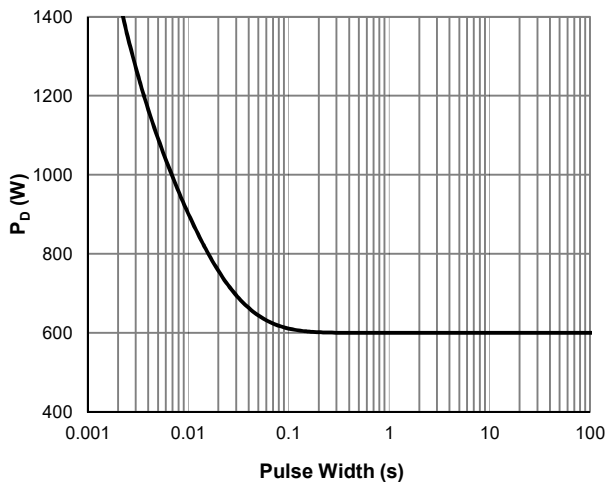
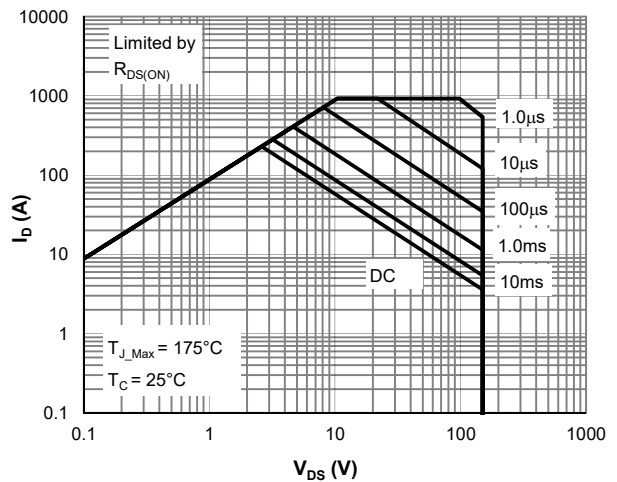
Figure 1: Saturation Characteristics

Figure 2: Transfer Characteristics

Figure 3: $R_{DS(ON)}$ vs. Drain Current

Figure 4: $R_{DS(ON)}$ vs. Junction Temperature

Figure 5: $V_{GS(th)}$ vs. Junction Temperature

Figure 6: $V_{BR(DSS)}$ vs. Junction Temperature

Typical Electrical & Thermal Characteristics

Figure 7: Body-Diode Characteristics

Figure 8: Capacitance Characteristics

Figure 9: Current De-rating

Figure 10: Power De-rating

Figure 11: Single Pulse Power Rating, Junction-to-Case

Figure 12: Maximum Safe Operating Area



Typical Electrical & Thermal Characteristics

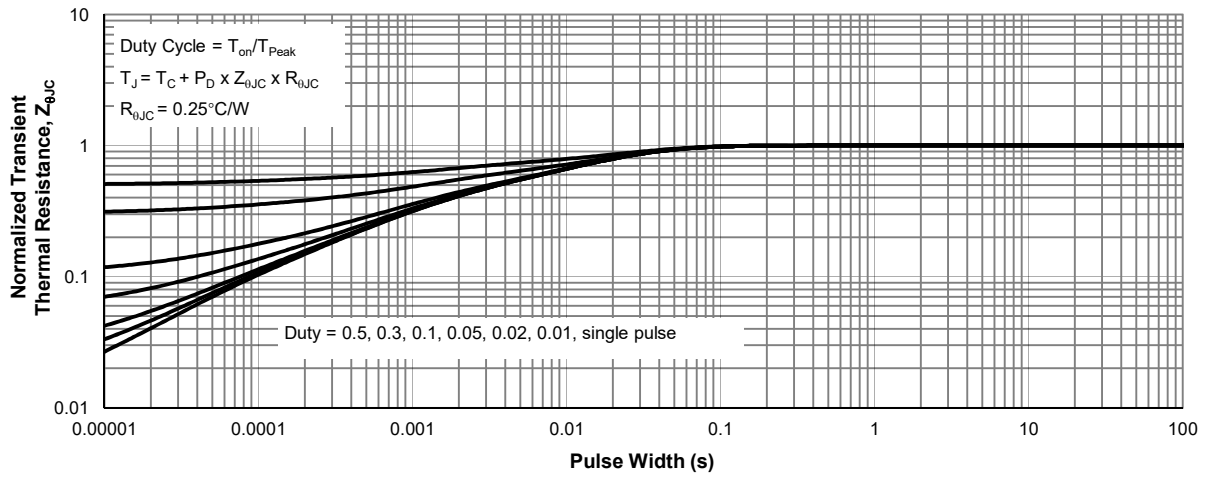
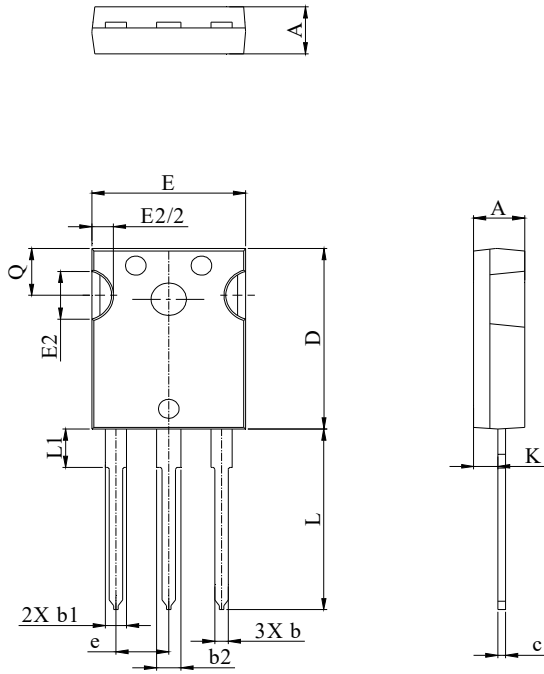

Figure 13: Normalized Maximum Transient Thermal Impedance

TO-247-3L Package Information
Package Outline

| DIM. | MILLIMETER | | |
|------|------------|-------|-------|
| | MIN. | NOM. | MAX. |
| A | 4.80 | 5.02 | 5.21 |
| b | 1.00 | 1.20 | 1.40 |
| b1 | 1.90 | 2.00 | 2.39 |
| b2 | 2.87 | 3.00 | 3.22 |
| c | 0.41 | 0.60 | 0.79 |
| D | 20.80 | 21.00 | 21.20 |
| E | 15.50 | 15.94 | 16.13 |
| E2 | 4.32 | | 5.49 |
| L | 19.70 | 20.07 | 20.32 |
| L1 | 4.00 | | 4.40 |
| K | 2.20 | | 2.50 |
| e | 5.44 BSC | | |