



40V 0.56mΩ N-Ch Power MOSFET

Features

- Ultra-low $R_{DS(ON)}$
- Low Gate Charge
- 100% UIS Tested, 100% R_g Tested
- Pb-free Lead Plating
- Halogen-free and RoHS-compliant

Product Summary

Parameter	Value	Unit
V_{DS}	40	V
$V_{GS(th_Typ)}$	2.8	V
$I_D (@ V_{GS} = 10V)^{(1)}$	384	A
$R_{DS(ON_Typ)} (@ V_{GS} = 10V)$	0.56	mΩ

Applications

- Power Management in Computing, CE, IE 4.0, Communications
- Current Switching in DC/DC & AC/DC (SR) Sub-systems
- Load Switching, Quick/Wireless Charging, Motor Driving

PDFN5x6-8L

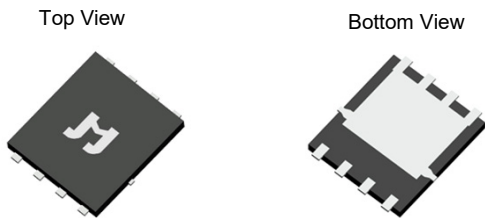

Pin Configuration

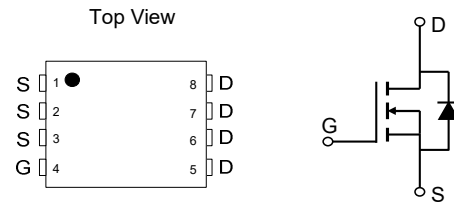

Ordering Information

Device	Package	# of Pins	Marking	MSL	T_J (°C)	Media	Quantity (pcs)
JMSH040SAG-13	PDFN5x6-8L	8	SH040SA	1	-55 to 150	13-inch Reel	5000

Absolute Maximum Ratings (@ $T_A = 25^\circ\text{C}$ unless otherwise specified)

Parameter	Symbol	Value	Unit
Drain-to-Source Voltage	V_{DS}	40	V
Gate-to-Source Voltage	V_{GS}	± 20	V
Continuous Drain Current ⁽¹⁾	I_D	$T_C = 25^\circ\text{C}$	384
		$T_C = 100^\circ\text{C}$	242
Pulsed Drain Current ⁽²⁾	I_{DM}	1238	A
Avalanche Energy ⁽³⁾	E_{AS}	864	mJ
Power Dissipation ⁽⁴⁾	P_D	$T_C = 25^\circ\text{C}$	178
		$T_C = 100^\circ\text{C}$	71
Junction & Storage Temperature Range	T_J, T_{STG}	-55 to 150	°C

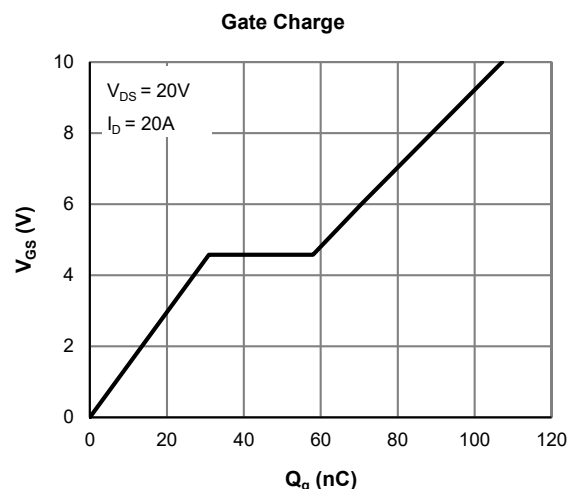
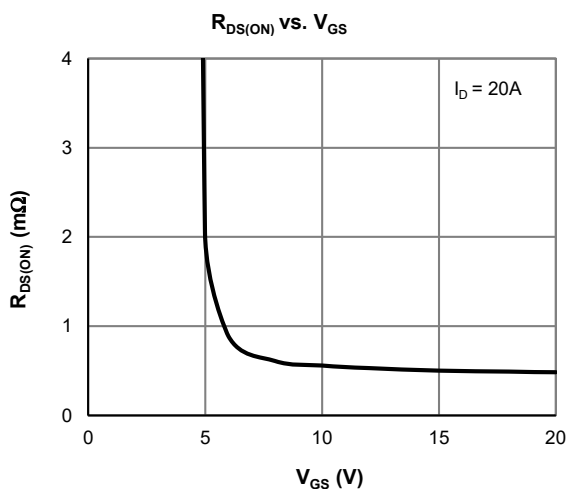



Electrical Characteristics (@ $T_J = 25^\circ\text{C}$ unless otherwise specified)

Parameter	Symbol	Conditions	Min.	Typ.	Max.	Unit
STATIC PARAMETERS						
Drain-Source Breakdown Voltage	$V_{(BR)DSS}$	$I_D = 250\mu\text{A}, V_{GS} = 0\text{V}$	40			V
Zero Gate Voltage Drain Current	I_{DSS}	$V_{DS} = 32\text{V}, V_{GS} = 0\text{V}$			1.0	μA
					5.0	
Gate-Body Leakage Current	I_{GSS}	$V_{DS} = 0\text{V}, V_{GS} = \pm 20\text{V}$			± 100	nA
Gate Threshold Voltage	$V_{GS(th)}$	$V_{DS} = V_{GS}, I_D = 250\mu\text{A}$	2.2	2.8	3.4	V
Static Drain-Source ON-Resistance	$R_{DS(ON)}$	$V_{GS} = 10\text{V}, I_D = 20\text{A}$		0.56	0.68	m Ω
Forward Transconductance	g_{FS}	$V_{DS} = 5\text{V}, I_D = 20\text{A}$		81		S
Diode Forward Voltage	V_{SD}	$I_S = 1\text{A}, V_{GS} = 0\text{V}$		0.63	1.0	V
Diode Continuous Current	I_S	$T_C = 25^\circ\text{C}$			178	A
DYNAMIC PARAMETERS ⁽⁵⁾						
Input Capacitance	C_{iss}	$V_{GS} = 0\text{V}, V_{DS} = 20\text{V}, f = 1\text{MHz}$		7445		pF
Output Capacitance	C_{oss}			5755		pF
Reverse Transfer Capacitance	C_{rss}			282		pF
Gate Resistance	R_g			2.5		Ω
SWITCHING PARAMETERS ⁽⁵⁾						
Total Gate Charge (@ $V_{GS} = 10\text{V}$)	Q_g	$V_{GS} = 0 \text{ to } 10\text{V}$ $V_{DS} = 20\text{V}, I_D = 20\text{A}$		107		nC
Total Gate Charge (@ $V_{GS} = 6.0\text{V}$)	Q_g			68		nC
Gate Source Charge	Q_{gs}			31		nC
Gate Drain Charge	Q_{gd}			27		nC
Turn-On DelayTime	$t_{D(on)}$	$V_{GS} = 10\text{V}, V_{DS} = 20\text{V}$ $R_L = 1.0\Omega, R_{GEN} = 3\Omega$		21		ns
Turn-On Rise Time	t_r			35		ns
Turn-Off DelayTime	$t_{D(off)}$			64		ns
Turn-Off Fall Time	t_f			35		ns
Body Diode Reverse Recovery Time	t_{rr}	$I_F = 20\text{A}, di_F/dt = 100\text{A}/\mu\text{s}$		87		ns
Body Diode Reverse Recovery Charge	Q_{rr}	$I_F = 20\text{A}, di_F/dt = 100\text{A}/\mu\text{s}$		169		nC

Thermal Performance

Parameter	Symbol	Typ.	Max.	Unit
Thermal Resistance, Junction-to-Ambient	$R_{\theta JA}$	40	48	$^\circ\text{C}/\text{W}$
Thermal Resistance, Junction-to-Case	$R_{\theta JC}$	0.70	0.90	$^\circ\text{C}/\text{W}$

Notes:

1. Computed continuous current assumes the condition of T_{J_Max} while the actual continuous current depends on the thermal & electro-mechanical application board design.
2. This single-pulse measurement was taken under $T_{J_Max} = 150^\circ\text{C}$.
3. E_{AS} of 864 mJ is based on starting $T_J = 25^\circ\text{C}, L = 3.0\text{mH}, I_{AS} = 24\text{A}, V_{GS} = 10\text{V}, V_{DD} = 20\text{V}; 100\%$ test at $L = 0.5\text{mH}, I_{AS} = 45\text{A}, T_{J_Max} = 150^\circ\text{C}$.
4. The power dissipation P_D is based on $T_{J_Max} = 150^\circ\text{C}$.
5. This value is guaranteed by design hence it is not included in the production test.

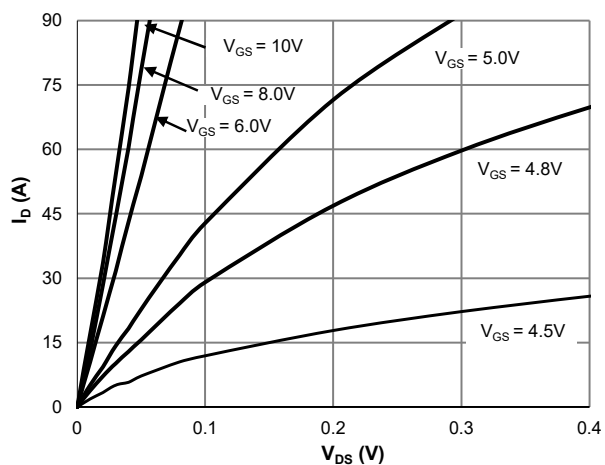
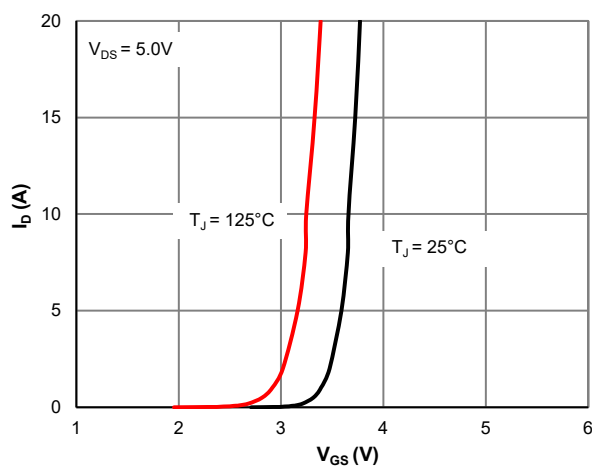
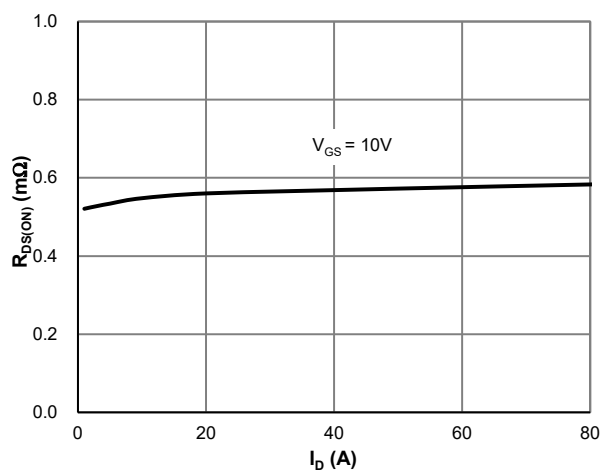
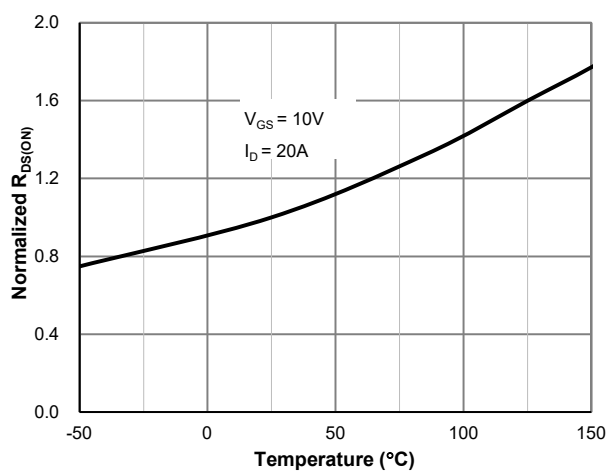
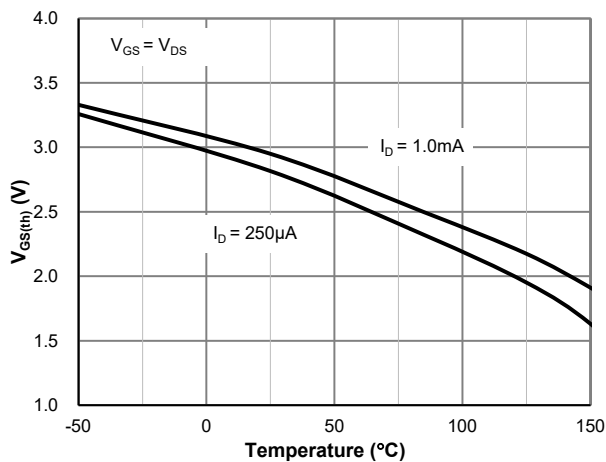
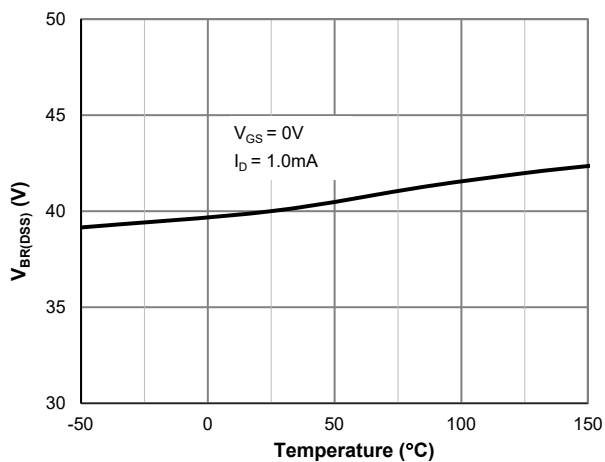
Typical Electrical & Thermal Characteristics

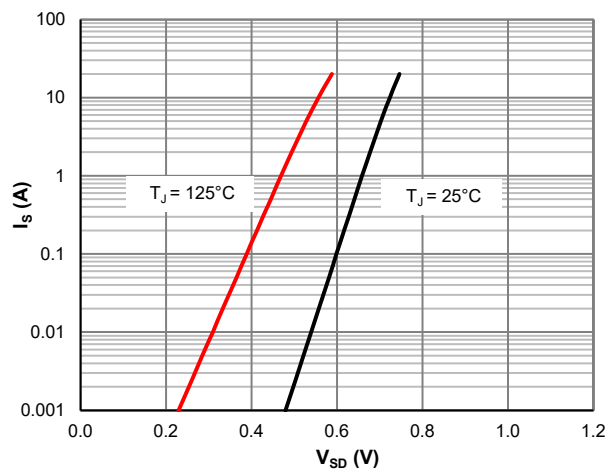
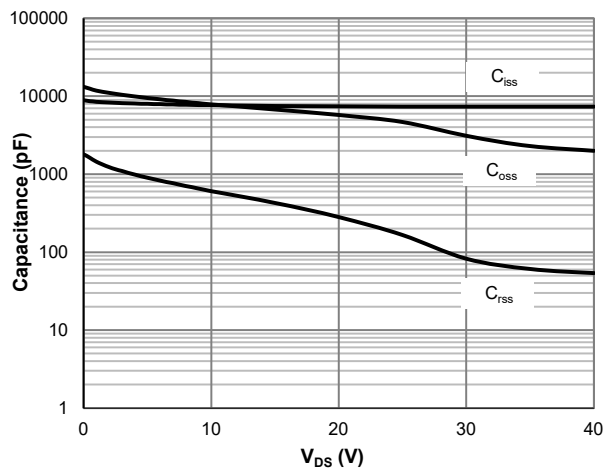
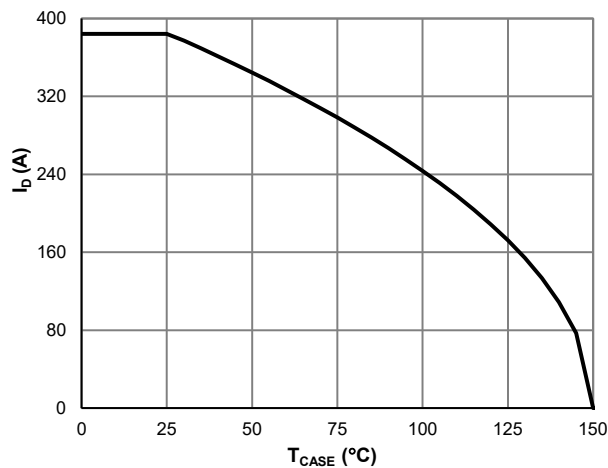
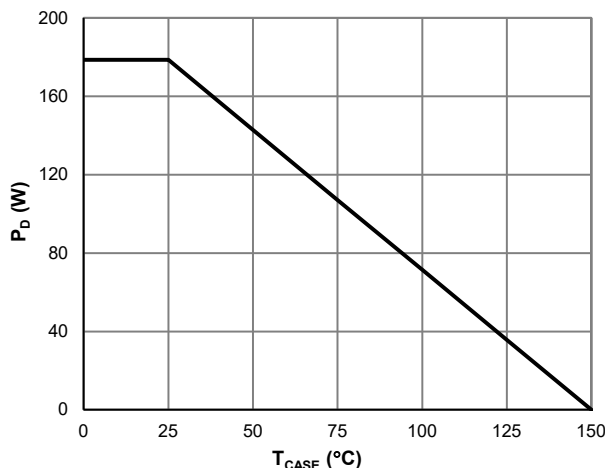
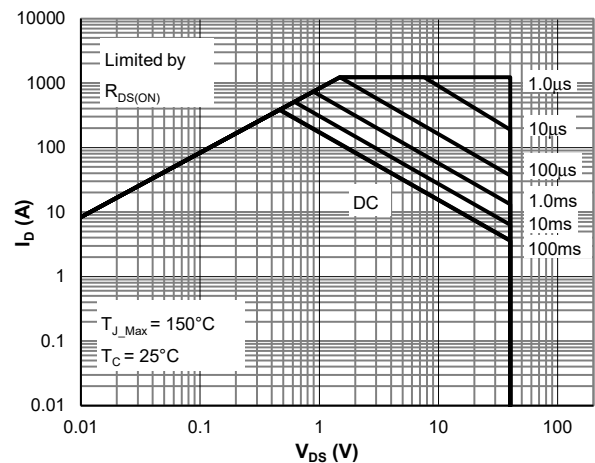
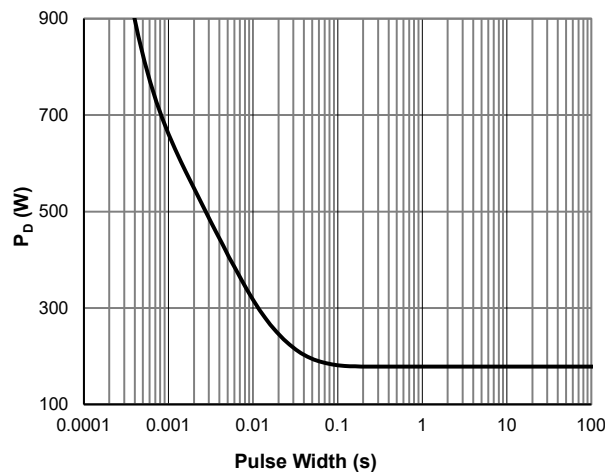
Figure 1: Saturation Characteristics

Figure 2: Transfer Characteristics

Figure 3: $R_{DS(ON)}$ vs. Drain Current

Figure 4: $R_{DS(ON)}$ vs. Junction Temperature

Figure 5: $V_{GS(th)}$ vs. Junction Temperature

Figure 6: $V_{BR(DSS)}$ vs. Junction Temperature

Typical Electrical & Thermal Characteristics

Figure 7: Body-Diode Characteristics

Figure 8: Capacitance Characteristics

Figure 9: Current De-rating

Figure 10: Power De-rating

Figure 11: Maximum Safe Operating Area

Figure 12: Single Pulse Power Rating, Junction-to-Case



Typical Electrical & Thermal Characteristics

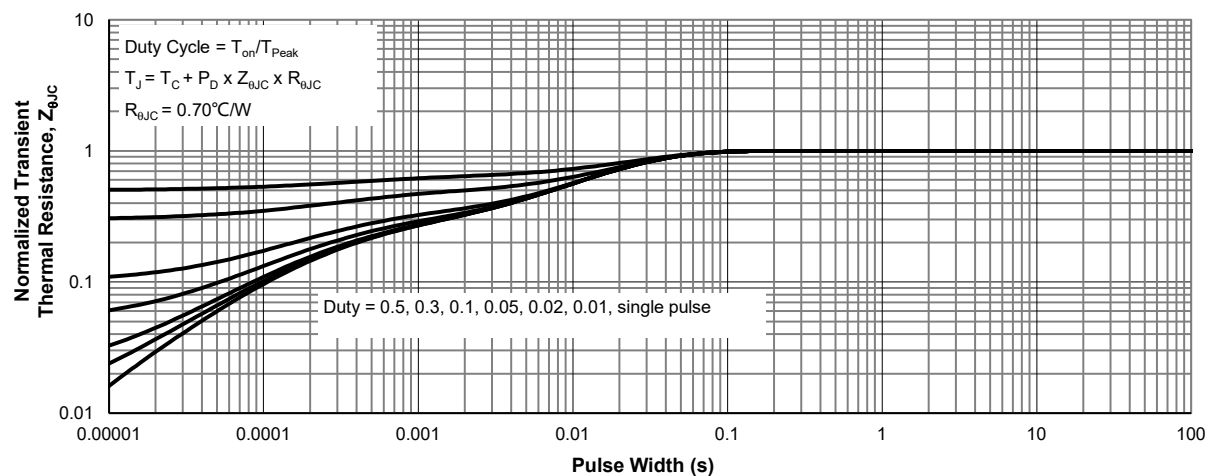
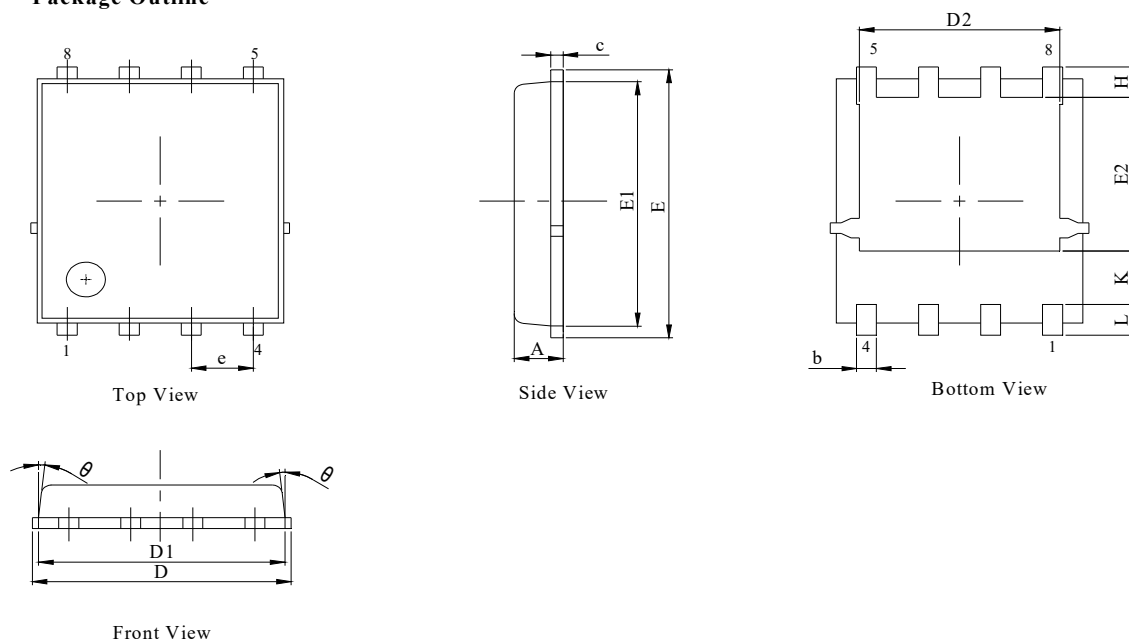
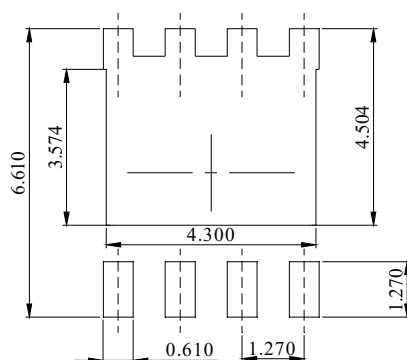

Figure 13: Normalized Maximum Transient Thermal Impedance

PDFN5x6-8L Package Information
Package Outline

NOTES:

1. Dimension and tolerance per ASME Y14.5M, 1994.
2. All dimensions in millimeter (angle in degree).
3. Dimensions $D1$ and $E1$ do not include mold flash protrusions or gate burrs.

DIM.	MILLIMETER		
	MIN.	NOM.	MAX.
A	0.90	1.00	1.10
b	0.31	0.41	0.51
c	0.20	0.25	0.30
D	5.00	5.20	5.40
D1	4.95	5.05	5.15
D2	4.00	4.10	4.20
E	6.05	6.15	6.25
E1	5.50	5.60	5.70
E2	3.42	3.53	3.63
e	1.27BSC		
H	0.60	0.70	0.80
L	0.50	0.70	0.80
K	1.23 REF		
θ	-	-	10°

Recommended Soldering Footprint

DIMENSIONS: MILLIMETERS