



650V SuperJunction Power MOSFET

Features

- Extremely Low Gate Charge
- Excellent Output Capacitance (C_{oss}) Profile
- Fast Switching Capability
- 100% UIS Tested, 100% R_g Tested
- Pb-free Lead Plating
- Halogen-free and RoHS-compliant
- AEC-Q101 Qualified for Automotive Applications

Product Summary

Parameter	Value	Unit
V_{DS}	650	V
$V_{GS(th)}_{Typ}$	3.5	V
$I_D (@ V_{GS} = 10V)^{(1)}$	35	A
$R_{DS(ON)}_{Typ} (@ V_{GS} = 10V)$	98	m Ω
$E_{oss@400V}$	7.8	μ J

Applications

- Switching Applications

TO-263-3L Top View

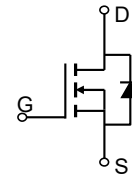
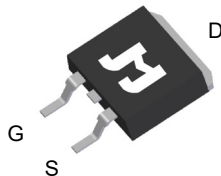

Ordering Information

Device	Package	# of Pins	Marking	MSL	T_J (°C)	Media	Quantity (pcs)
JMH65R110AEFDQ-13	TO-263-3L	3	65R110AF	1	-55 to 150	Tube	800

Absolute Maximum Ratings (@ $T_A = 25^\circ\text{C}$ unless otherwise specified)

Parameter	Symbol	Value	Unit
Drain-to-Source Voltage	V_{DS}	650	V
Gate-to-Source Voltage	V_{GS}	± 30	V
Continuous Drain Current ⁽¹⁾	I_D	$T_C = 25^\circ\text{C}$	35
		$T_C = 100^\circ\text{C}$	21
Pulsed Drain Current ⁽²⁾	I_{DM}	137	A
Avalanche Current ⁽³⁾	I_{AS}	10.0	A
Avalanche Energy ⁽³⁾	E_{AS}	500	mJ
Power Dissipation ⁽⁴⁾	P_D	$T_C = 25^\circ\text{C}$	313
		$T_C = 100^\circ\text{C}$	125
Junction & Storage Temperature Range	T_J, T_{STG}	-55 to 150	°C

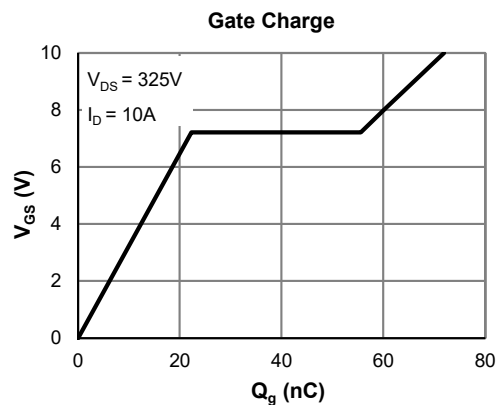
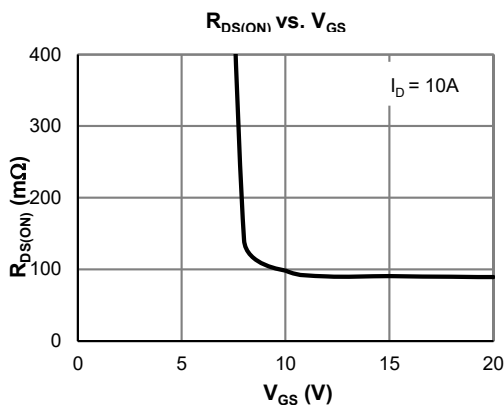

**Electrical Characteristics** (@ $T_J = 25^\circ\text{C}$ unless otherwise specified)

Parameter	Symbol	Conditions	Min.	Typ.	Max.	Unit
STATIC PARAMETERS						
Drain-Source Breakdown Voltage	$V_{(BR)DSS}$	$I_D = 250\mu\text{A}$, $V_{GS} = 0\text{V}$	650			V
Zero Gate Voltage Drain Current	I_{DSS}	$V_{DS} = 650\text{V}$, $V_{GS} = 0\text{V}$			10.0	μA
Gate-Body Leakage Current	I_{GSS}	$V_{DS} = 0\text{V}$, $V_{GS} = \pm 30\text{V}$			± 100	nA
Gate Threshold Voltage	$V_{GS(th)}$	$V_{DS} = V_{GS}$, $I_D = 250\mu\text{A}$	2.5	3.5	4.5	V
Static Drain-Source ON-Resistance	$R_{DS(ON)}$	$V_{GS} = 10\text{V}$, $I_D = 10\text{A}$		98	110	m Ω
Diode Forward Voltage	V_{SD}	$I_S = 1\text{A}$, $V_{GS} = 0\text{V}$		0.75		V
Diode Continuous Current	I_S	$T_C = 25^\circ\text{C}$			10	A
DYNAMIC PARAMETERS ⁽⁵⁾						
Input Capacitance	C_{iss}	$V_{GS} = 0\text{V}$, $V_{DS} = 100\text{V}$, $f = 1\text{MHz}$		2869		pF
Output Capacitance	C_{oss}			93		pF
Effective output capacitance, energy related	$C_{o(er)}$	$V_{GS}=0\text{V}$, $V_{DS}=0\dots 400\text{V}$		97		pF
Effective output capacitance, time related	$C_{o(tr)}$	$I_D=\text{constant}$, $V_{GS}=0\text{V}$, $V_{DS}=0\dots 400\text{V}$		410		pF
Reverse Transfer Capacitance	C_{rss}	$V_{GS} = 0\text{V}$, $V_{DS} = 100\text{V}$, $f = 1\text{MHz}$		5.4		pF
Gate Resistance	R_g	$f = 1\text{MHz}$		2.2		Ω
SWITCHING PARAMETERS ⁽⁵⁾						
Total Gate Charge (@ $V_{GS} = 10\text{V}$)	Q_g	$V_{GS} = 0$ to 10V $V_{DS} = 325\text{V}$, $I_D = 10\text{A}$		72		nC
Gate Source Charge	Q_{gs}			22		nC
Gate Drain Charge	Q_{gd}			33		nC
Turn-On DelayTime	$t_{D(on)}$	$V_{GS} = 10\text{V}$, $V_{DS} = 325\text{V}$ $R_L = 32.5\Omega$, $R_{GEN} = 6\Omega$		29		ns
Turn-On Rise Time	t_r			30		ns
Turn-Off DelayTime	$t_{D(off)}$			77		ns
Turn-Off Fall Time	t_f			17.4		ns
Body Diode Reverse Recovery Time	t_{rr}	$I_F = 10\text{A}$, $di/dt = 100\text{A}/\mu\text{s}$		152		ns
Body Diode Reverse Recovery Charge	Q_{rr}	$I_F = 10\text{A}$, $di/dt = 100\text{A}/\mu\text{s}$		2.5		μC
Peak Diode Recovery Voltage Slope	dv/dt	$I_F \leq 2\text{A}$, $di/dt = 200\text{A}/\mu\text{s}$, $V_{DS} = 400\text{V}$		15.0		V/ns
MOSFET dv/dt Ruggedness	dv/dt	$V_{DS} = 0\dots 400\text{V}$		50		V/ns

Thermal Performance

Parameter	Symbol	Typ.	Max.	Unit
Thermal Resistance, Junction-to-Ambient	$R_{\theta JA}$	45	55	$^\circ\text{C}/\text{W}$
Thermal Resistance, Junction-to-Case	$R_{\theta JC}$	0.40	0.48	$^\circ\text{C}/\text{W}$

Notes:

1. Computed continuous current assumes the condition of T_{J_Max} while the actual continuous current depends on the thermal & electro-mechanical application board design.
2. This single-pulse measurement was taken under $T_{J_Max} = 150^\circ\text{C}$.
3. This single-pulse measurement was taken under the following condition [$L = 10\text{mH}$, $V_{GS} = 10\text{V}$, $V_{DD} = 50\text{V}$] while its value is limited by $T_{J_Max} = 150^\circ\text{C}$.
4. The power dissipation P_D is based on $T_{J_Max} = 150^\circ\text{C}$.
5. This value is guaranteed by design hence it is not included in the production test.

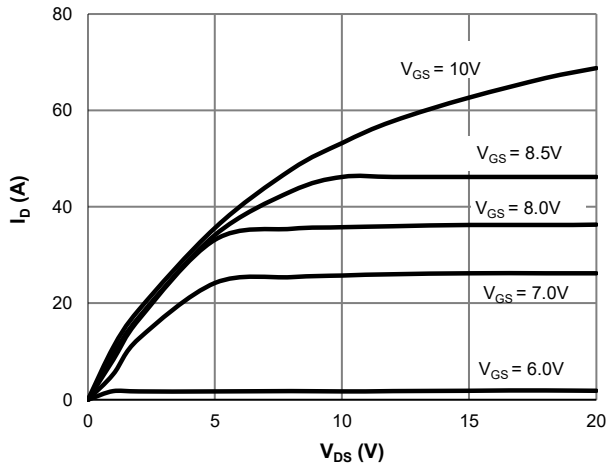
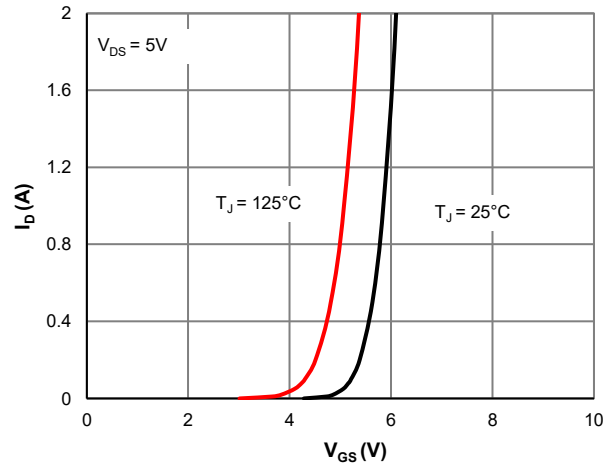
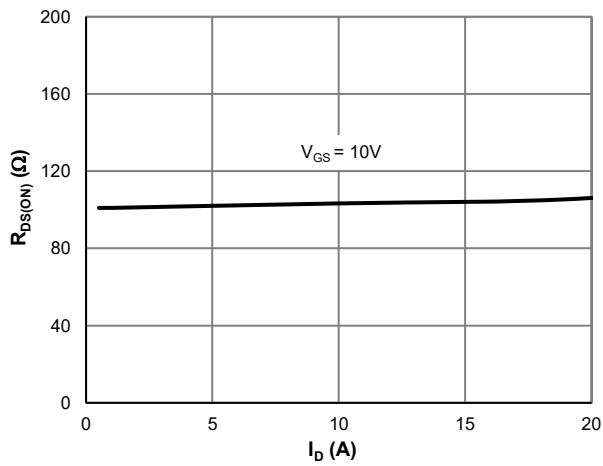
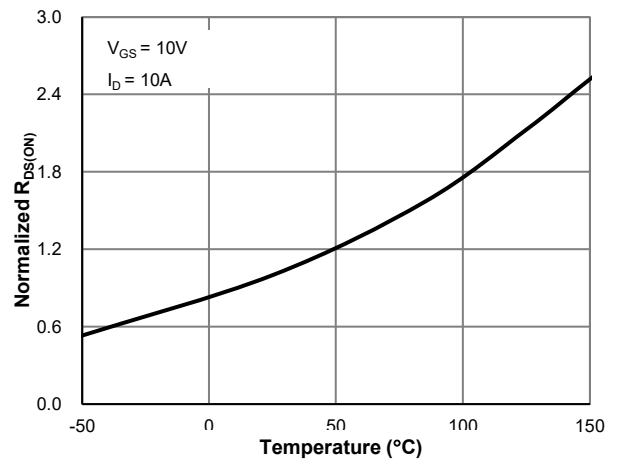
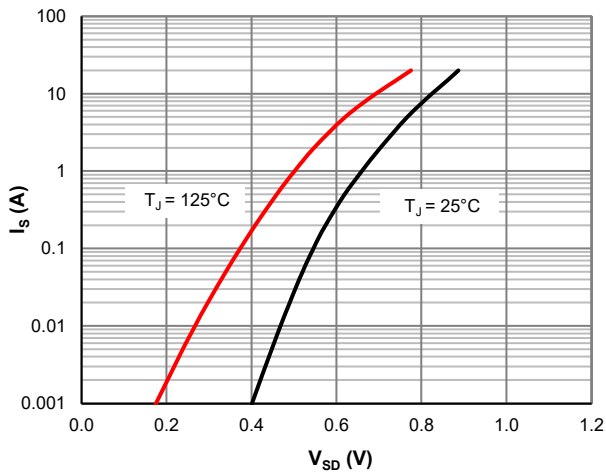
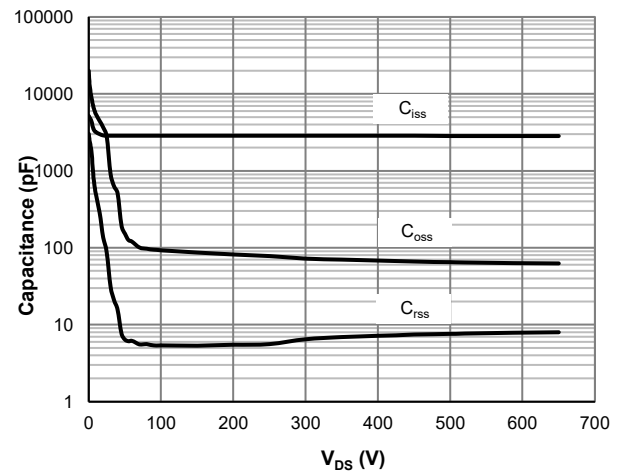
Typical Electrical & Thermal Characteristics

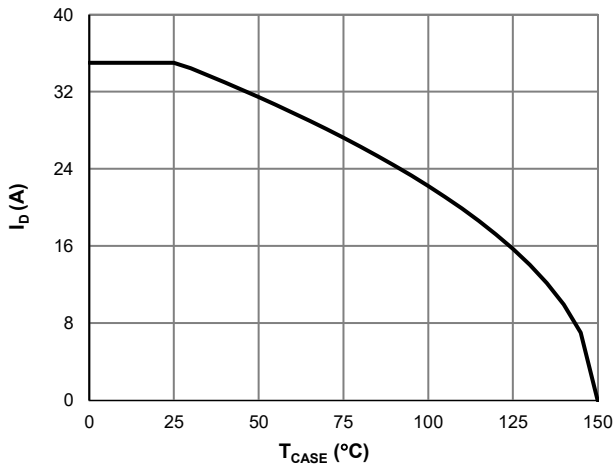
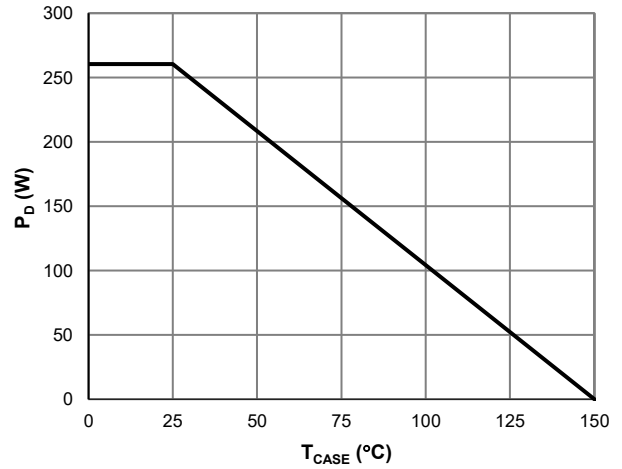
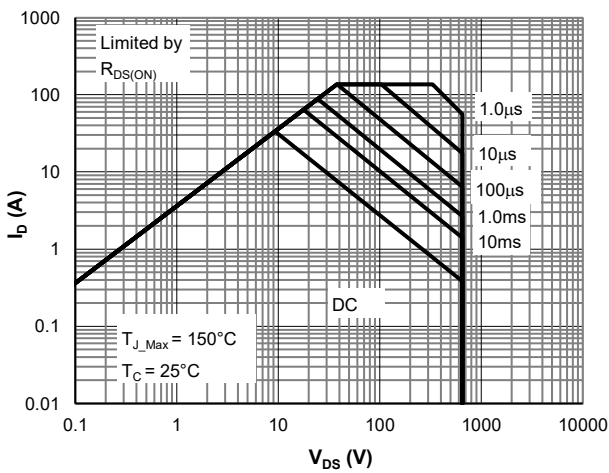
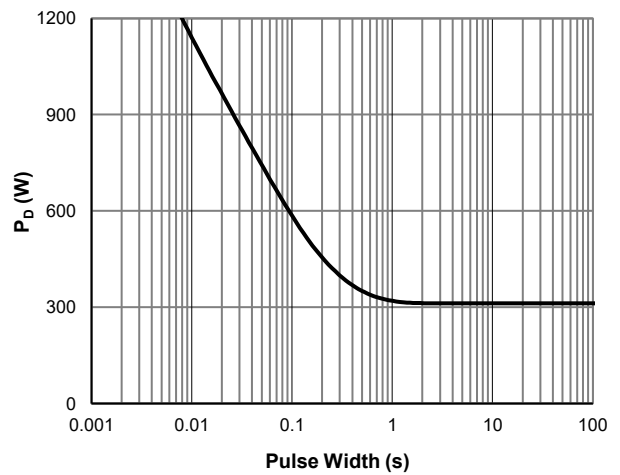
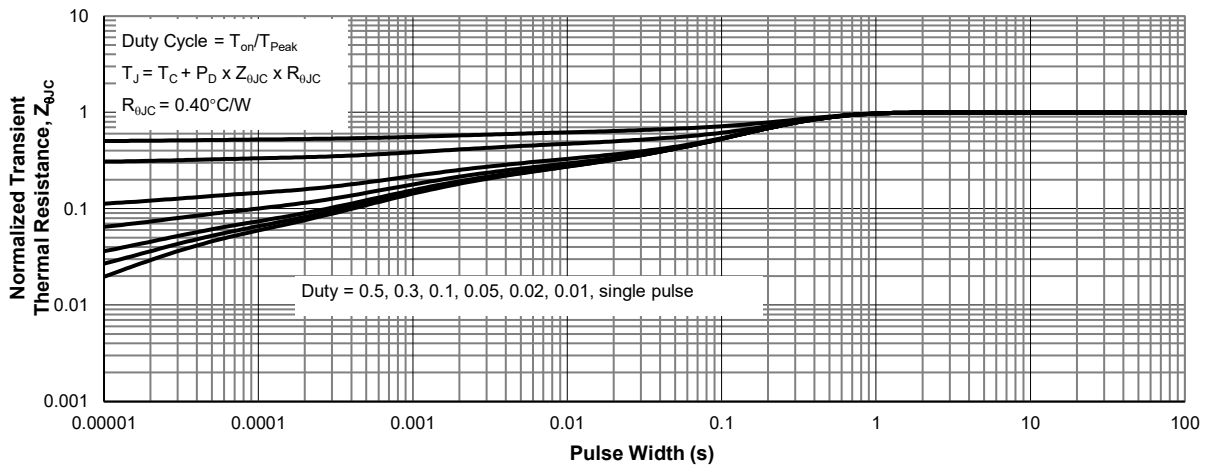
Figure 1: Saturation Characteristics

Figure 2: Transfer Characteristics

Figure 3: $R_{DS(ON)}$ vs. Drain Current

Figure 4: $R_{DS(ON)}$ vs. Junction Temperature

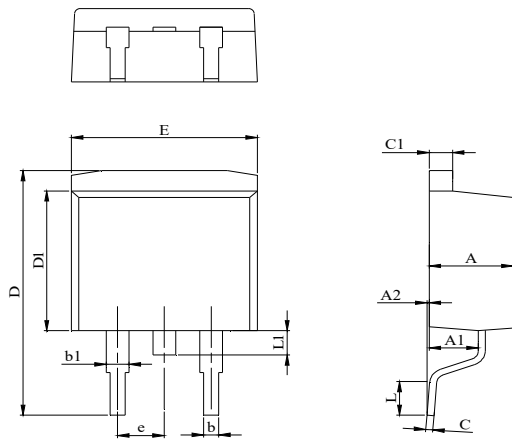
Figure 5: Body-Diode Characteristics

Figure 6: Capacitance Characteristics

Typical Electrical & Thermal Characteristics

Figure 7: Current De-rating

Figure 8: Power De-rating

Figure 9: Maximum Safe Operating Area

Figure 10: Single Pulse Power Rating, Junction-to-Case

Figure 11: Normalized Maximum Transient Thermal Impedance



TO-263-3L Package Information

Package Outline



DIM.	MILLIMETER		
	MIN.	NOM.	MAX.
A	4.24		4.77
A1	2.30		2.89
A2	0.00	0.10	0.25
b	0.70		0.96
b1	1.17		1.70
C	0.30		0.60
C1	1.15		1.42
D	14.10		15.88
D1	8.50		9.60
E	9.78		10.36
L	1.78		2.79
L1			1.75
e		2.54	

Recommend Soldering Footprint

