



## 650V SuperJunction Power MOSFET

### Features

- Extremely Low Gate Charge
- Excellent Output Capacitance ( $C_{oss}$ ) Profile
- Fast Switching Capability
- Ultra Fast Body Diode
- 100% UIS Tested, 100%  $R_g$  Tested
- Pb-free Lead Plating
- Halogen-free and RoHS-compliant

### Product Summary

Parameter	Value	Unit
$V_{DS}$	650	V
$V_{GS(th)}_{Typ}$	4.0	V
$I_D$ (@ $V_{GS} = 10V$ ) <sup>(1)</sup>	71	A
$R_{DS(ON)}_{Typ}$ (@ $V_{GS} = 10V$ )	35	mΩ
$E_{oss@400V}$	16.0	μJ

### Applications

- Telecom / Server Power Supplies
- Industrial Power Supplies
- UPS / Solar
- Lighting / Charger / Adapter

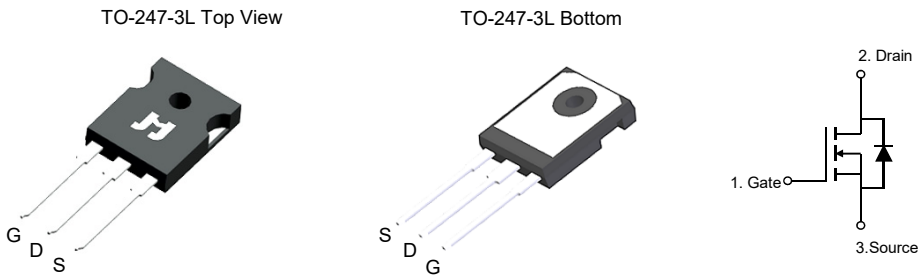

### Ordering Information

Device	Package	# of Pins	Marking	MSL	$T_J$ (°C)	Media	Quantity (pcs)
JMH65R040ASFD-U	TO-247-3L	3	H65R040AF	NA	-55 to 150	Tube	30

### Absolute Maximum Ratings (@ $T_A = 25^\circ C$ unless otherwise specified)

Parameter	Symbol	Value	Unit
Drain-to-Source Voltage	$V_{DS}$	650	V
Gate-to-Source Voltage	$V_{GS}$	±20	V
Continuous Drain Current <sup>(1)</sup>	$I_D$	$T_C = 25^\circ C$	71
		$T_C = 100^\circ C$	45
Pulsed Drain Current <sup>(2)</sup>	$I_{DM}$	260	A
Avalanche Current <sup>(3)</sup>	$I_{AS}$	15.0	A
Avalanche Energy <sup>(3)</sup>	$E_{AS}$	1125	mJ
Power Dissipation <sup>(4)</sup>	$P_D$	$T_C = 25^\circ C$	500
		$T_C = 100^\circ C$	200
Junction & Storage Temperature Range	$T_J, T_{STG}$	-55 to 150	°C

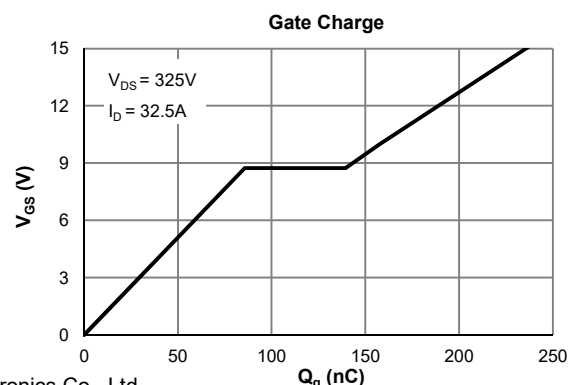
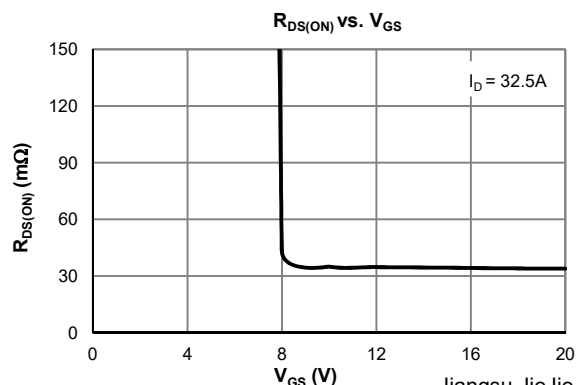

**Electrical Characteristics** (@  $T_J = 25^\circ\text{C}$  unless otherwise specified)

Parameter	Symbol	Conditions	Min.	Typ.	Max.	Unit
<b>STATIC PARAMETERS</b>						
Drain-Source Breakdown Voltage	$V_{(BR)DSS}$	$I_D = 250\mu\text{A}, V_{GS} = 0\text{V}$	650			V
Zero Gate Voltage Drain Current	$I_{DSS}$	$V_{DS} = 650\text{V}, V_{GS} = 0\text{V}$			5.0	$\mu\text{A}$
Gate-Body Leakage Current	$I_{GSS}$	$V_{DS} = 0\text{V}, V_{GS} = \pm 20\text{V}$			$\pm 100$	nA
Gate Threshold Voltage	$V_{GS(th)}$	$V_{DS} = V_{GS}, I_D = 250\mu\text{A}$	3.0	4.0	5.0	V
Static Drain-Source ON-Resistance	$R_{DS(on)}$	$V_{GS} = 10\text{V}, I_D = 32.5\text{A}$		35	40	m $\Omega$
Diode Forward Voltage	$V_{SD}$	$I_S = 1\text{A}, V_{GS} = 0\text{V}$		0.75	1.0	V
Diode Continuous Current	$I_S$	$T_C = 25^\circ\text{C}$			71	A
<b>DYNAMIC PARAMETERS</b> <sup>(5)</sup>						
Input Capacitance	$C_{iss}$	$V_{GS} = 0\text{V}, V_{DS} = 100\text{V}, f = 1\text{MHz}$		6843		pF
Output Capacitance	$C_{oss}$			250		pF
Reverse Transfer Capacitance	$C_{rss}$			4.3		pF
Effective output capacitance, energy related	$C_{o(er)}$	$V_{GS} = 0\text{V}, V_{DS} = 0 \text{ to } 400\text{V}$		200		pF
Effective output capacitance, time related	$C_{o(tr)}$			2036		pF
Gate Resistance	$R_g$	$V_{GS} = 0\text{V}, V_{DS} = 0\text{V}, f = 1\text{MHz}$		0.66		$\Omega$
<b>SWITCHING PARAMETERS</b> <sup>(5)</sup>						
Total Gate Charge (@ $V_{GS} = 10\text{V}$ )	$Q_g$	$V_{GS} = 0 \text{ to } 10\text{V}$ $V_{DS} = 325\text{V}, I_D = 10\text{A}$		163		nC
Gate Source Charge	$Q_{gs}$			81		nC
Gate Drain Charge	$Q_{gd}$			54		nC
Turn-On DelayTime	$t_{D(on)}$	$V_{GS} = 10\text{V}, V_{DS} = 325\text{V}$ $R_L = 3.25\Omega, R_{GEN} = 6\Omega$		52.0		ns
Turn-On Rise Time	$t_r$			84		ns
Turn-Off DelayTime	$t_{D(off)}$			63		ns
Turn-Off Fall Time	$t_f$			10.6		ns
Body Diode Reverse Recovery Time	$t_{rr}$	$I_F = 32.5\text{A}, di/dt = 100\text{A}/\mu\text{s}$		195		ns
Body Diode Reverse Recovery Charge	$Q_{rr}$	$I_F = 32.5\text{A}, di/dt = 100\text{A}/\mu\text{s}$		1.7		$\mu\text{C}$
Peak Diode Recovery Voltage Slope	$dv/dt$	$I_F \leq 32.5\text{A}, di/dt = 200\text{A}/\mu\text{s}, V_{DS} = 400\text{V}$		50		V/ns
MOSFET $dv/dt$ Ruggedness	$dv/dt$	$V_{DS} = 0 \dots 400\text{V}$		50		V/ns

**Thermal Performance**

Parameter	Symbol	Typ.	Max.	Unit
Thermal Resistance, Junction-to-Ambient	$R_{\theta JA}$	40	50	$^\circ\text{C}/\text{W}$
Thermal Resistance, Junction-to-Case	$R_{\theta JC}$	0.25	0.30	$^\circ\text{C}/\text{W}$

**Notes:**

1. Computed continuous current assumes the condition of  $T_{J\_Max}$  while the actual continuous current depends on the thermal & electro-mechanical application board design.
2. This single-pulse measurement was taken under  $T_{J\_Max} = 150^\circ\text{C}$ .
3. This single-pulse measurement was taken under the following condition [ $L = 10\text{mH}, V_{GS} = 10\text{V}, V_{DD} = 50\text{V}$ ] while its value is limited by  $T_{J\_Max} = 150^\circ\text{C}$ .
4. The power dissipation  $P_D$  is based on  $T_{J\_Max} = 150^\circ\text{C}$ .
5. This value is guaranteed by design hence it is not included in the production test.

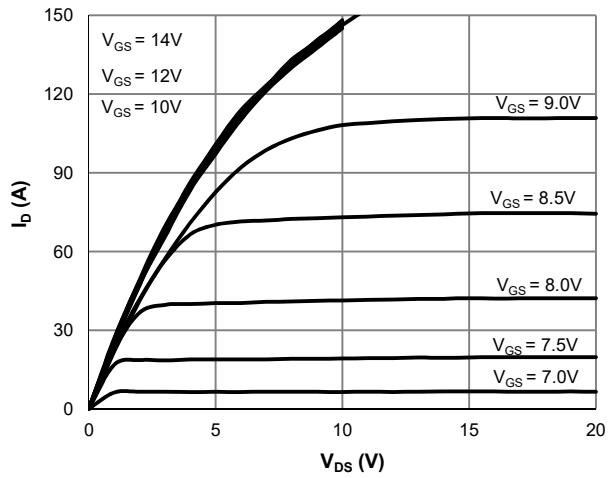
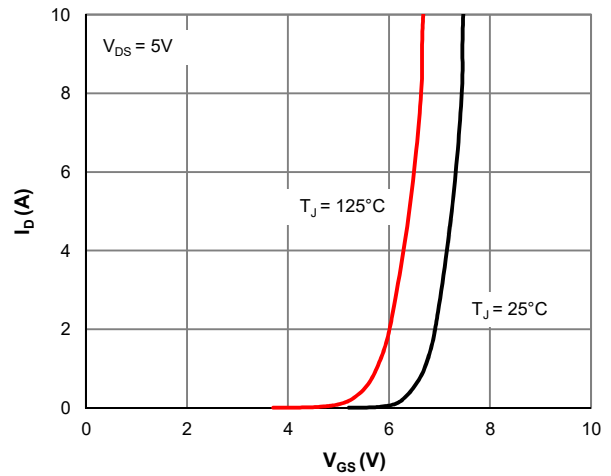
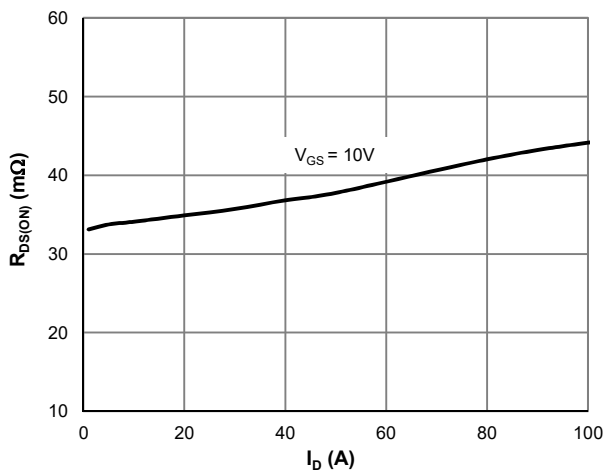
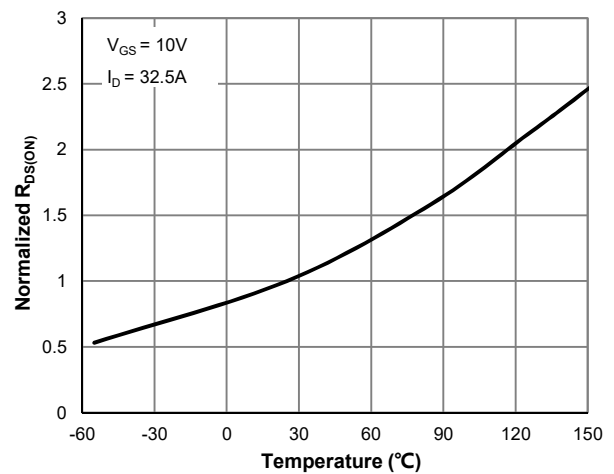
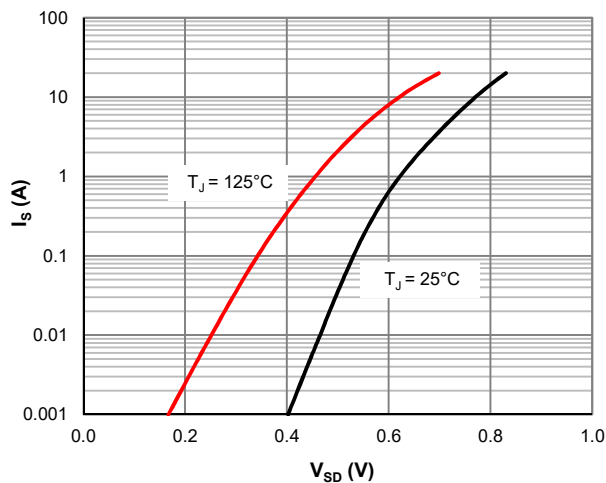
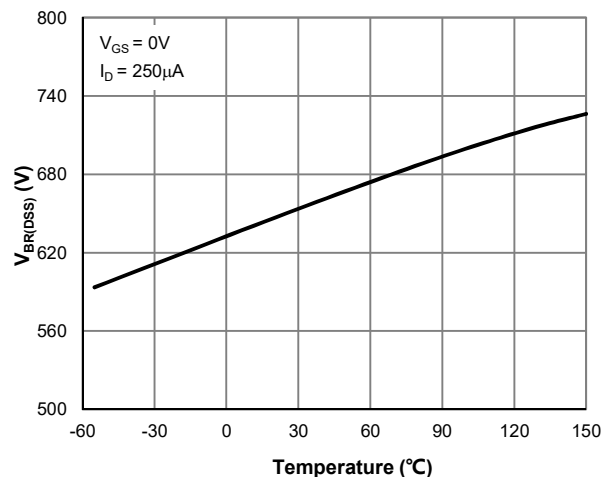
**Typical Electrical & Thermal Characteristics**

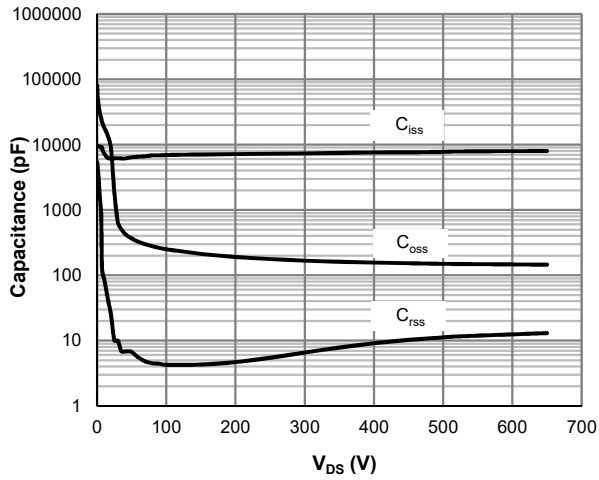
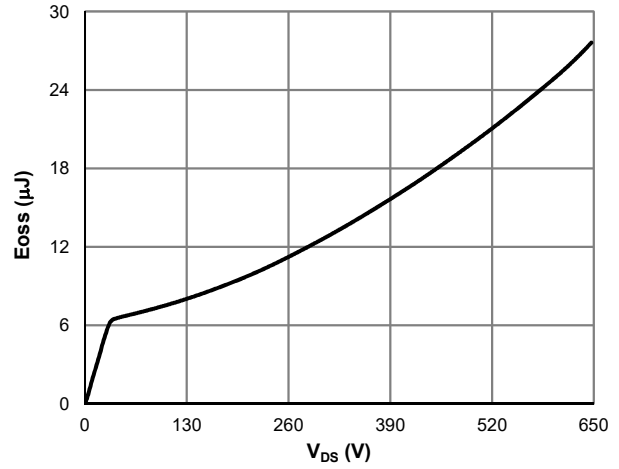
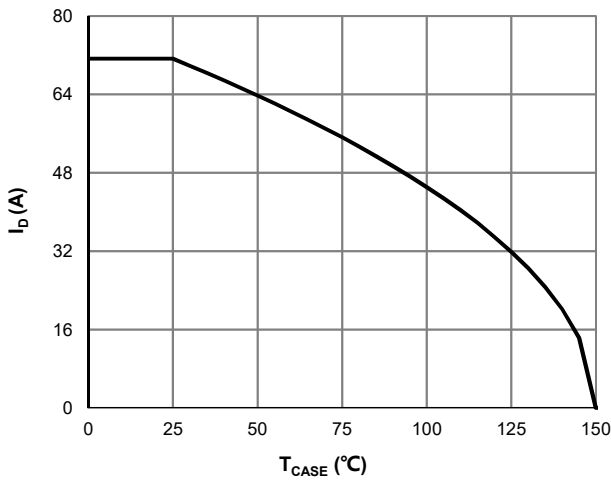
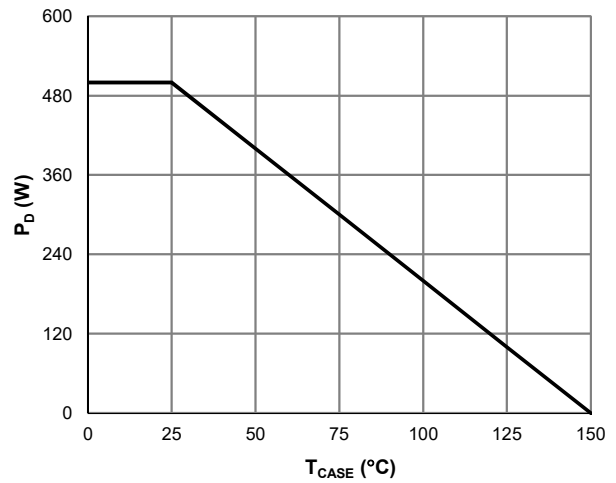
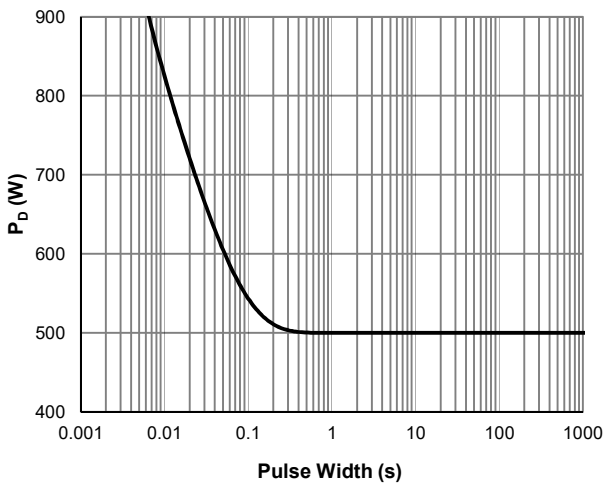
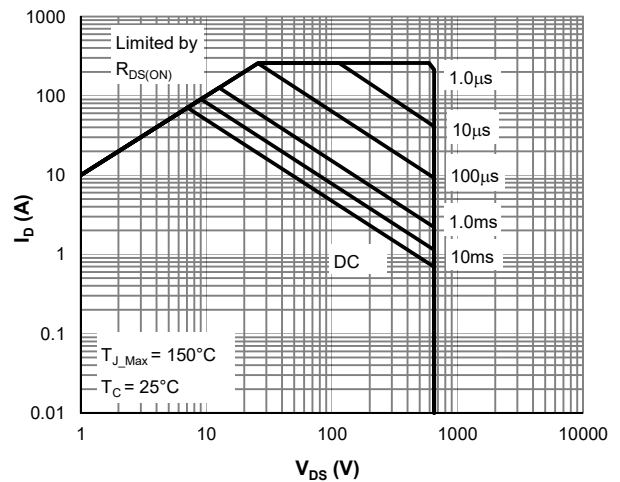
**Figure 1: Saturation Characteristics**

**Figure 2: Transfer Characteristics**

**Figure 3:  $R_{DS(ON)}$  vs. Drain Current**

**Figure 4:  $R_{DS(ON)}$  vs. Junction Temperature**

**Figure 5: Body-Diode Characteristics**

**Figure 6:  $V_{BR(DSS)}$  vs. Junction Temperature**

**Typical Electrical & Thermal Characteristics**

**Figure 7: Capacitance Characteristics**

**Figure 8: Coss Stored Energy**

**Figure 9: Current De-rating**

**Figure 10: Power De-rating**

**Figure 11: Single Pulse Power Rating, Junction-to-Case**

**Figure 12: Maximum Safe Operating Area**



### Typical Electrical & Thermal Characteristics

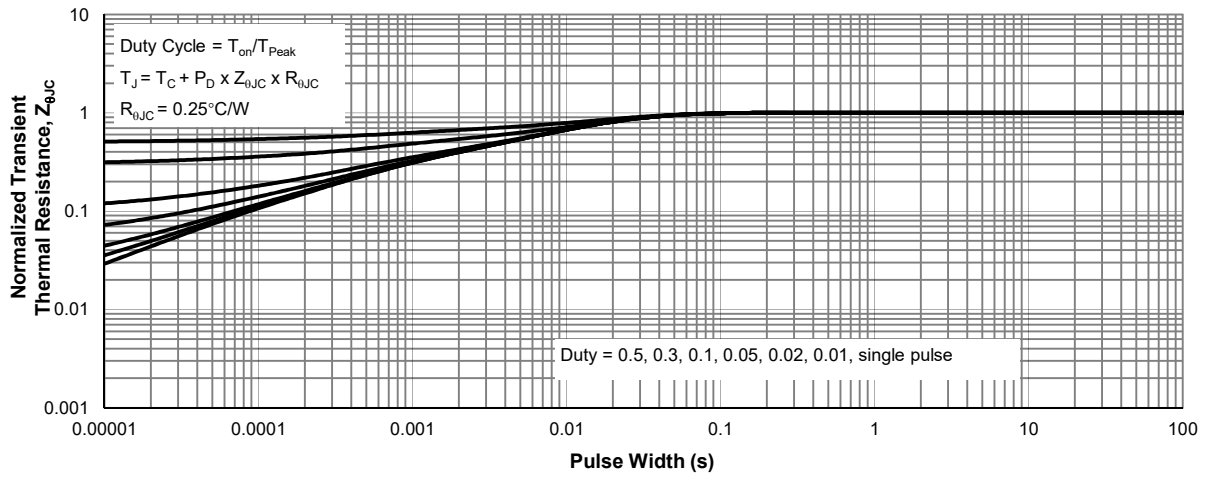
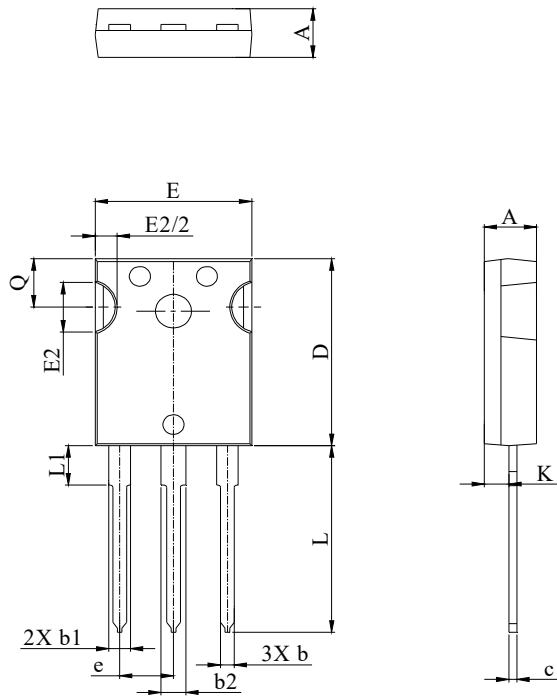

Figure 13: Normalized Maximum Transient Thermal Impedance

**TO-247-3L Package Information**
**Package Outline**

DIM.	MILLIMETER		
	MIN.	NOM.	MAX.
A	4.80	5.02	5.21
b	1.00	1.20	1.40
b1	1.90	2.00	2.39
b2	2.87	3.00	3.22
c	0.41	0.60	0.79
D	20.80	21.00	21.20
E	15.50	15.94	16.13
E2	4.32		5.49
L	19.70	20.07	20.32
L1	4.00		4.40
K	2.20		2.50
e	5.44 BSC		