



SMDJ30CA-3L Transient Voltage Suppressor

Rev.1.0

DESCRIPTION

TVS diodes can be used in a wide range of applications which like consumer electronic products, automotive industries, munitions, telecommunications, aerospace industries, and intelligent control systems.



SMC-3

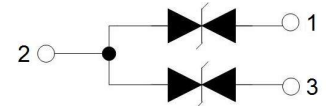

Symbol

FEATURES

- ✧ Low profile package.
- ✧ Low inductance.
- ✧ Excellent clamping capability.
- ✧ Fast response time: typically less than 1.0ps from 0V to V_{BR} min.
- ✧ High temperature to reflow soldering: 260°C/40s at terminals.
- ✧ Plastic package has underwriters laboratory flammability 94V-0.
- ✧ Meets MSL level 1, per J-STD-020, LF maximum peak of 260°C.
- ✧ Terminal: solder plated, solderable per J-STD-002.
- ✧ For surface mounted applications in order to optimize board space.
- ✧ UL 497B item recognized. (File No.:E480698).
- ✧ IEC61000-4-2 (ESD) ± 30 kV (air), ± 30 kV (contact).

ABSOLUTE MAXIMUM RATINGS ($T_A=25^\circ\text{C}$, RH=45%-75%, unless otherwise noted)

Parameter	Symbol	Value	Unit
Storage temperature range	T_{STG}	-55 to +150	°C
Operating junction temperature range	T_J	-55 to +150	°C
Peak pulse current at 1.2/50-8/20 μs @2 Ω waveform	I_{PP}	750	A
Peak pulse voltage at 10/700 μs @40 Ω waveform	V_{PP}	6000	V
Typical thermal resistance junction to lead	$R_{\theta JL}$	30	°C/W
Typical thermal resistance junction to ambient	$R_{\theta JA}$	80	°C/W

Notes:

1. Surge rating: 750A@1.2/50-8/20 μs (PIN 1 or 3 to 2)
2. Surge rating: 6000V@10/700 μs (PIN 1 or 3 to 2)

MARKING

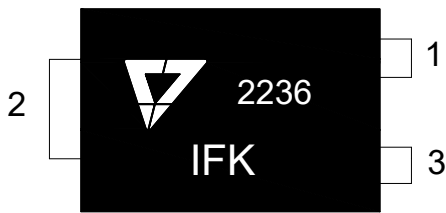

IFK: Device Marking Code
2236: the 36th week, 2022

ELECTRICAL CHARACTERISTICS (T_A=25°C)

Part Number	I _R @V _R		V _{BR} ^① @I _T		I _T	V _C @I _{PP} ^②	V _C @V _{PP} ^③	V _C @I _{PP} ^④	I _{PP} ^④	C _O ^⑤	Marking
	μA	V	V	V	mA	V	V	V	A	pF	
	max		min	max		typ	typ	max		typ	
SMDJ30CA-3L	1	30	33.3	36.8	1	48.0	48.0	48.4	62	3000	IFK

① V_{BR} is measured at I_T=1mA (PIN1 or 3 to 2)

② Surge waveform: 1.2/50-8/20μs I_{PP}: 750A (PIN1 or 3 to 2)

③ Surge waveform: 10/700μs V_{PP}: 6000V (PIN1 or 3 to 2)

④ Surge waveform: 10/1000μs (PIN1 or 3 to 2)

⑤ Off-state capacitance is measured in V_{DC}=0V, V_{RMS}=1V, f=1MHz (PIN1 or 3 to 2)

ORDERING INFORMATION

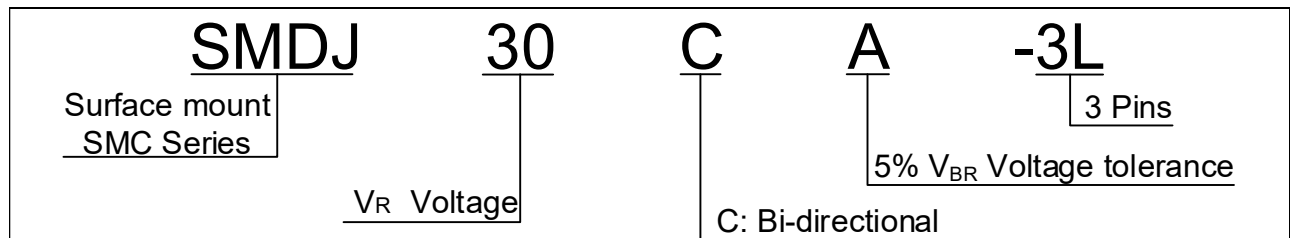

RATINGS AND V-I CHARACTERISTICS CURVES ($T_A=25^{\circ}\text{C}$, unless otherwise noted)

FIG.1: V- I curve characteristics (Bi-directional)

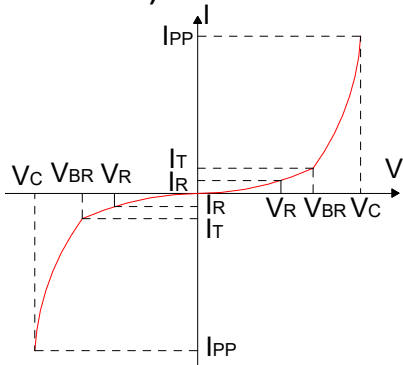

FIG.2: Pulse waveform

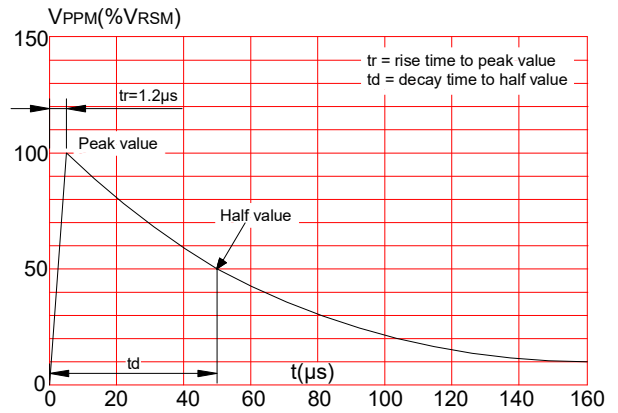

FIG.3: Pulse waveform

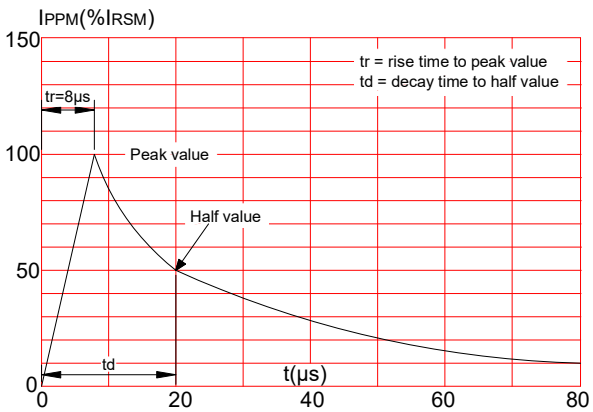

FIG.4: Pulse waveform

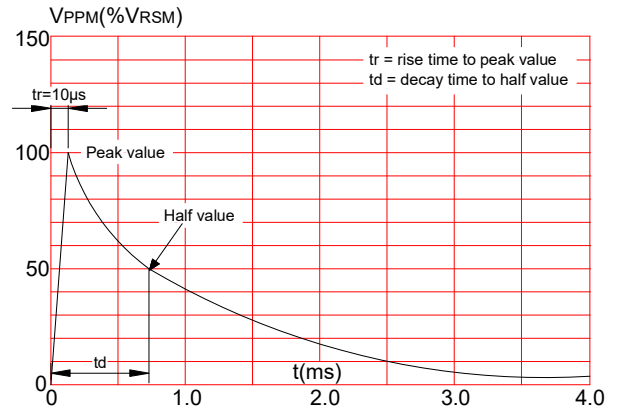
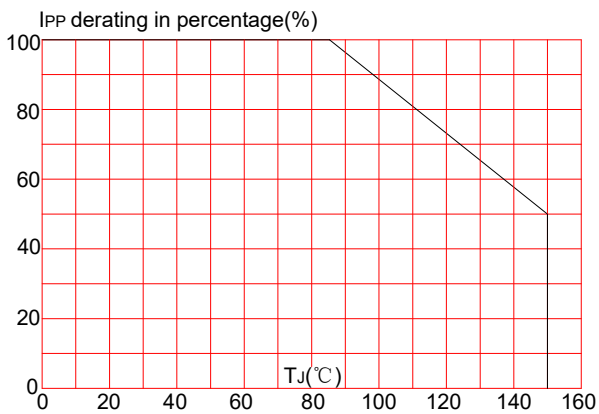
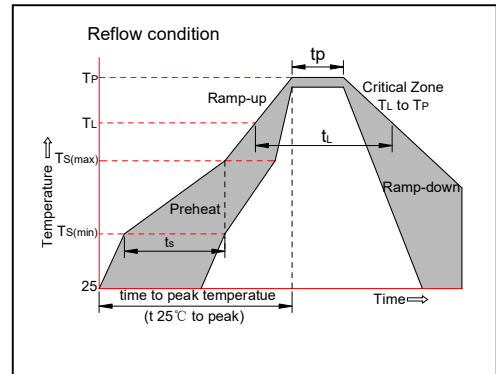

FIG.5: Pulse derating curve(8/20\mu s)



SOLDERING PARAMETERS

Reflow Condition		Pb-Free assembly (see figure at right)
Pre Heat	-Temperature Min ($T_{s(min)}$)	+150°C
	-Temperature Max($T_{s(max)}$)	+200°C
	-Time (Min to Max) (t_s)	60-180 secs.
Average ramp up rate (Liquidus Temp (T_L) to peak)		3°C/sec. Max
$T_{s(max)}$ to T_L - Ramp-up Rate		3°C/sec. Max
Reflow	-Temperature(T_L)(Liquidus)	+217°C
	-Temperature(t_L)	60-150 secs.
Peak Temp (T_p)		+260(+0/-5)°C
Time within 5°C of actual Peak Temp (t_p)		20-40secs.
Ramp-down Rate		6°C/sec. Max
Time 25°C to Peak Temp (T_p)		8 min. Max
Do not exceed		+260°C



PACKAGE MECHANICAL DATA

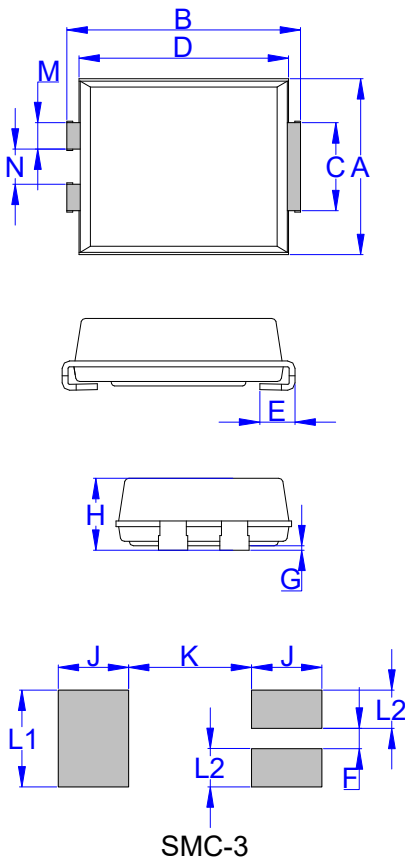

Ref.	Dimensions			
	Millimeters		Inches	
	Min.	Max.	Min.	Max.
A	5.75	6.25	0.226	0.246
B	7.70	8.20	0.303	0.323
C	2.75	3.25	0.108	0.128
D	6.90	7.40	0.272	0.291
E	0.95	1.52	0.037	0.060
G	-	0.30	-	0.012
H	2.15	2.62	0.085	0.103
M	0.70	1.10	0.028	0.043
N	1.00	1.40	0.039	0.055
L2	1.30		0.051	
F	0.70		0.028	
J	2.40		0.094	
K		4.20		0.165
L1	3.30		0.130	

TAPE AND REEL SPECIFICATION-SMC-3

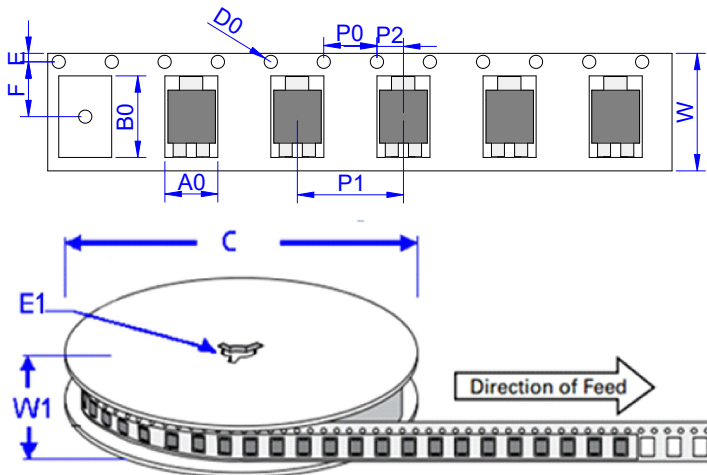

Ref.	Dimensions	
	Millimeters	Inches
A0	6.05 ± 0.3	0.238 ± 0.012
B0	8.31 ± 0.3	0.327 ± 0.012
C	330.0	13.0
D0	1.55 ± 0.1	0.061 ± 0.004
E	1.75 ± 0.2	0.069 ± 0.008
E1	13.3 ± 0.3	0.524 ± 0.012
F	7.50 ± 0.2	0.295 ± 0.008
P0	4.00 ± 0.2	0.157 ± 0.008
P1	8.00 ± 0.2	0.3145 ± 0.008
P2	2.00 ± 0.2	0.079 ± 0.008
W	16.0 ± 0.2	0.630 ± 0.008
W1	19.7 ± 2.0	0.776 ± 0.079

PART No.	UNIT WEIGHT (g/PCS) typ.	REEL (PCS)	PER CARTON (PCS)	DESCRIPTION
SMDJ30CA-3L	0.33	3,000	48,000	13 inch reel pack

JieJie products are not designed for, and shall not be used for, any purpose (including, without limitation, automotive, military, aerospace, medical, life-saving, life-sustaining or nuclear facility applications, devices intended for surgical implant into the body, or any other application in which the failure or lack of desired operation of the product may result in personal injury, death, or property damage) other than those expressly set forth in applicable JieJie product documentation. Warranties granted by JieJie shall be deemed void for products used for any purpose not expressly set forth in applicable JieJie documentation. JieJie shall not be liable for any claims or damages arising out of products used in applications not expressly intended by JieJie as set forth in applicable JieJie documentation. The sale and use of JieJie products is subject to JieJie terms and conditions of sale, unless otherwise agreed by JieJie.

Information furnished in this document is believed to be accurate and reliable. However, Jiangsu JieJie Microelectronics Co., Ltd. assumes no responsibility for the consequences of use without consideration for such information nor use beyond it.

Information mentioned in this document is subject to change without notice, apart from that when an agreement is signed, Jiangsu JieJie complies with the agreement.

Products and information provided in this document have no infringement of patents. Jiangsu JieJie assumes no responsibility for any infringement of other rights of third parties which may result from the use of such products and information.

This document is the first version which is made in 19-Sept.-2022. This document supersedes and replaces all information previously supplied.

 is a registered trademark of Jiangsu JieJie Microelectronics Co., Ltd.

Copyright ©2022 Jiangsu JieJie Microelectronics Co., Ltd. Printed All rights reserved.